

# Pilot's Handbook of Aeronautical Knowledge

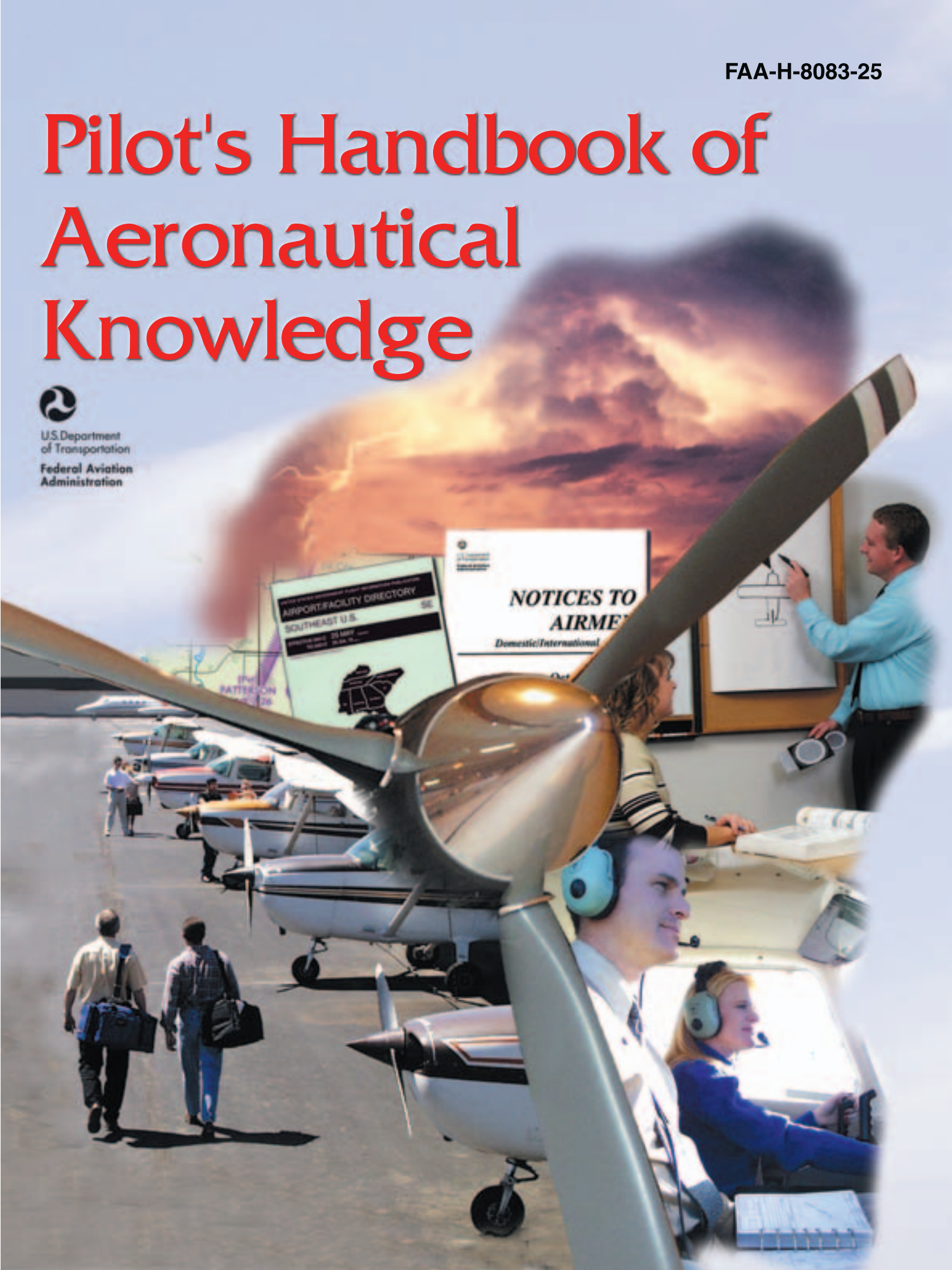

U.S. Department  
of Transportation  
Federal Aviation  
Administration

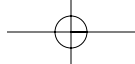



# **PILOT'S HANDBOOK of Aeronautical Knowledge**

**2003**

**U.S. DEPARTMENT OF TRANSPORTATION  
FEDERAL AVIATION ADMINISTRATION  
Flight Standards Service**

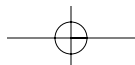

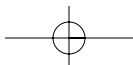
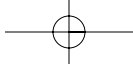

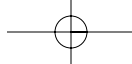

## PREFACE

The *Pilot's Handbook of Aeronautical Knowledge* provides basic knowledge that is essential for pilots. This handbook introduces pilots to the broad spectrum of knowledge that will be needed as they progress in their pilot training. Except for the Code of Federal Regulations pertinent to civil aviation, most of the knowledge areas applicable to pilot certification are presented. This handbook is useful to beginning pilots, as well as those pursuing more advanced pilot certificates.

Occasionally, the word “must” or similar language is used where the desired action is deemed critical. The use of such language is not intended to add to, interpret, or relieve a duty imposed by Title 14 of the Code of Federal Regulations (14 CFR).

It is essential for persons using this handbook to also become familiar with and apply the pertinent parts of 14 CFR and the *Aeronautical Information Manual* (AIM). The AIM is available online at <http://www.faa.gov/atpubs>.

The current Flight Standards Service airman training and testing material and subject matter knowledge codes for all airman certificates and ratings can be obtained from the Flight Standards Service Web site at <http://av-info.faa.gov>.

This handbook supersedes Advisory Circular (AC) 61-23C, *Pilot's Handbook of Aeronautical Knowledge*, dated 1997.

This publication may be purchased from the Superintendent of Documents, U.S. Government Printing Office (GPO), Washington, DC 20402-9325, or from <http://bookstore.gpo.gov>. This handbook is also available for download from the Flight Standards Service Web site at <http://av-info.faa.gov>.

This handbook is published by the U.S. Department of Transportation, Federal Aviation Administration, Airman Testing Standards Branch, AFS-630, P.O. Box 25082, Oklahoma City, OK 73125. Comments regarding this handbook should be sent in e-mail form to [AFS630comments@faa.gov](mailto:AFS630comments@faa.gov).

AC 00-2, *Advisory Circular Checklist*, transmits the current status of FAA advisory circulars and other flight information and publications. This checklist is available via the Internet at [http://www.faa.gov/aba/html\\_policies/ac00\\_2.html](http://www.faa.gov/aba/html_policies/ac00_2.html).

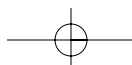

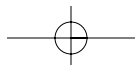
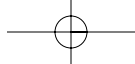

# CONTENTS

## Chapter 1—Aircraft Structure

Major Components .....	1-1
Fuselage .....	1-2
Wings .....	1-3
Empennage .....	1-4
Landing Gear .....	1-4
The Powerplant.....	1-5

## Chapter 2—Principles of Flight

Structure of the Atmosphere.....	2-1
Atmospheric Pressure.....	2-2
Effects of Pressure on Density .....	2-2
Effect of Temperature on Density .....	2-2
Effect of Humidity on Density .....	2-2
Newton's Laws of Motion and Force.....	2-2
Magnus Effect .....	2-3
Bernoulli's Principle of Pressure.....	2-3
Airfoil Design.....	2-4
Low Pressure Above.....	2-5
High Pressure Below .....	2-6
Pressure Distribution .....	2-6

## Chapter 3—Aerodynamics of Flight

Forces Acting on the Airplane.....	3-1
Thrust.....	3-2
Drag .....	3-3
Weight.....	3-5
Lift .....	3-6
Wingtip Vortices .....	3-6
Ground Effect .....	3-7
Axes of an Airplane.....	3-8
Moments and Moment Arm .....	3-9
Design Characteristics .....	3-9
Basic Concepts of Stability .....	3-10
Static Stability .....	3-10
Dynamic Stability .....	3-11
Longitudinal Stability (Pitching).....	3-11
Lateral Stability (Rolling) .....	3-14
Vertical Stability (Yawing).....	3-15
Free Directional Oscillations (Dutch Roll).....	3-16
Spiral Instability .....	3-16
Aerodynamic Forces in Flight Maneuvers..	3-17
Forces in Turns .....	3-17
Forces in Climbs.....	3-19
Forces in Descents.....	3-19
Stalls .....	3-20
Basic Propeller Principles .....	3-21
Torque and P Factor.....	3-23
Torque Reaction.....	3-23
Corkscrew Effect .....	3-24
Gyroscopic Action .....	3-24

Asymmetric Loading (P Factor).....	3-25
Load Factors .....	3-26
Load Factors in Airplane Design.....	3-26
Load Factors in Steep Turns.....	3-27
Load Factors and Stalling Speeds .....	3-28
Load Factors and Flight Maneuvers.....	3-29
VG Diagram .....	3-30
Weight and Balance.....	3-31
Effects of Weight on Flight Performance .....	3-32
Effect of Weight on Airplane Structure..	3-32
Effects of Weight on Stability and Controllability.....	3-33
Effect of Load Distribution .....	3-33
High Speed Flight.....	3-35
Supersonic vs. Subsonic Flow.....	3-35
Speed Ranges.....	3-35
Mach Number vs. Airspeed.....	3-36
Boundary Layer.....	3-36
Shock Waves.....	3-37
Sweepback.....	3-38
Mach Buffet Boundaries.....	3-39
Flight Controls.....	3-40

## Chapter 4—Flight Controls

Primary Flight Controls.....	4-1
Ailerons .....	4-1
Adverse Yaw .....	4-2
Differential Ailerons .....	4-2
Frise-Type Ailerons .....	4-2
Coupled Ailerons and Rudder .....	4-3
Elevator.....	4-3
T-Tail.....	4-3
Stabilator.....	4-4
Canard.....	4-5
Rudder .....	4-5
V-Tail .....	4-6
Secondary Flight Controls.....	4-6
Flaps.....	4-6
Leading Edge Devices.....	4-7
Spoilers .....	4-7
Trim Systems.....	4-8
Trim Tabs.....	4-8
Balance Tabs.....	4-8
Antiservo Tabs.....	4-8
Ground Adjustable Tabs .....	4-9
Adjustable Stabilizer .....	4-9

## Chapter 5—Aircraft Systems

Powerplant.....	5-1
Reciprocating Engines.....	5-1
Propeller.....	5-2

Fixed-Pitch Propeller.....	5-3	Turbojet.....	5-30
Adjustable-Pitch Propeller.....	5-4	Turboprop.....	5-30
Induction Systems.....	5-5	Turbofan.....	5-30
Carburetor Systems.....	5-5	Turboshaft.....	5-31
Mixture Control.....	5-5	Performance Comparison.....	5-31
Carburetor Icing.....	5-6	Turbine Engine Instruments.....	5-31
Carburetor Heat.....	5-7	Engine Pressure Ratio.....	5-32
Carburetor Air Temperature Gauge.....	5-8	Exhaust Gas Temperature.....	5-32
Outside Air Temperature Gauge.....	5-8	Torquemeter.....	5-32
Fuel Injection Systems.....	5-8	N1 Indicator.....	5-32
Superchargers and Turbosuperchargers.....	5-9	N2 Indicator.....	5-32
Superchargers.....	5-9	Turbine Engine Operational	
Turbosuperchargers.....	5-10	Considerations.....	5-32
System Operation.....	5-10	Engine Temperature Limitations.....	5-32
High Altitude Performance.....	5-11	Thrust Variations.....	5-32
Ignition System.....	5-11	Foreign Object Damage.....	5-32
Combustion.....	5-12	Turbine Engine Hot/Hung Start.....	5-33
Fuel Systems.....	5-13	Compressor Stalls.....	5-33
Fuel Pumps.....	5-14	Flameout.....	5-33
Fuel Primer.....	5-14	<b>Chapter 6—Flight Instruments</b>	
Fuel Tanks.....	5-14	Pitot-Static Flight Instruments.....	6-1
Fuel Gauges.....	5-14	Impact Pressure Chamber and Lines.....	6-1
Fuel Selectors.....	5-14	Static Pressure Chamber and Lines.....	6-1
Fuel Strainers, Sumps, and Drains.....	5-14	Altimeter.....	6-2
Fuel Grades.....	5-15	Principle of Operation.....	6-2
Fuel Contamination.....	5-15	Effect of Nonstandard Pressure and	
Refueling Procedures.....	5-16	Temperature.....	6-2
Starting System.....	5-16	Setting the Altimeter.....	6-3
Oil Systems.....	5-16	Altimeter Operation.....	6-4
Engine Cooling Systems.....	5-18	Types of Altitude.....	6-4
Exhaust Systems.....	5-19	Indicated Altitude.....	6-4
Electrical System.....	5-19	True Altitude.....	6-4
Hydraulic Systems.....	5-22	Absolute Altitude.....	6-4
Landing Gear.....	5-22	Pressure Altitude.....	6-4
Tricycle Landing Gear Airplanes.....	5-22	Density Altitude.....	6-5
Tailwheel Landing Gear Airplanes.....	5-23	Vertical Speed Indicator.....	6-5
Fixed and Retractable Landing Gear.....	5-23	Principle of Operation.....	6-5
Brakes.....	5-23	Airspeed Indicator.....	6-6
Autopilot.....	5-23	Indicated Airspeed.....	6-6
Pressurized Airplanes.....	5-24	Calibrated Airspeed.....	6-6
Oxygen Systems.....	5-26	True Airspeed.....	6-6
Masks.....	5-27	Groundspeed.....	6-6
Diluter Demand Oxygen Systems.....	5-27	Airspeed Indicator Markings.....	6-6
Pressure Demand Oxygen Systems.....	5-27	Other Airspeed Limitations.....	6-7
Continuous Flow Oxygen System.....	5-27	Blockage of the Pitot-Static System.....	6-8
Servicing of Oxygen Systems.....	5-28	Blocked Pitot System.....	6-8
Ice Control Systems.....	5-28	Blocked Static System.....	6-8
Airfoil Ice Control.....	5-28	Gyroscopic Flight Instruments.....	6-9
Windscreen Ice Control.....	5-29	Gyroscopic Principles.....	6-9
Propeller Ice Control.....	5-29	Rigidity in Space.....	6-9
Other Ice Control Systems.....	5-29	Precession.....	6-9
Turbine Engines.....	5-29	Sources of Power.....	6-10
Types of Turbine Engines.....	5-30	Turn Indicators.....	6-10



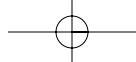

Turn-and-Slip Indicator .....6-11  
 Turn Coordinator .....6-11  
 Inclinator .....6-11  
 The Attitude Indicator .....6-12  
 Heading Indicator .....6-12  
 Magnetic Compass .....6-14  
 Compass Errors .....6-15  
     Variation.....6-15  
     Compass Deviation.....6-16  
     Magnetic Dip .....6-16  
     Using the Magnetic Compass.....6-16  
         Acceleration/Deceleration Errors ...6-16  
         Turning Errors .....6-16  
 Vertical Card Compass .....6-17  
 Outside Air Temperature Gauge.....6-17

**Chapter 7—Flight Manuals and Other Documents**

Airplane Flight Manuals.....7-1  
     Preliminary Pages .....7-1  
     General (Section 1).....7-2  
     Limitations (Section 2).....7-2  
         Airspeed.....7-2  
         Powerplant .....7-2  
         Weight and Loading Distribution.....7-2  
         Flight Limits .....7-3  
         Placards.....7-3  
     Emergency Procedures (Section 3) .....7-3  
     Normal Procedures (Section 4) .....7-3  
     Performance (Section 5).....7-3  
     Weight and Balance/Equipment List (Section 6) .....7-3  
     Systems Description (Section 7) .....7-4  
     Handling, Service, and Maintenance (Section 8) .....7-4  
     Supplements (Section 9).....7-4  
     Safety Tips (Section 10).....7-5  
 Aircraft Documents .....7-5  
     Certificate of Aircraft Registration.....7-5  
     Airworthiness Certificate.....7-6  
 Aircraft Maintenance.....7-7  
     Aircraft Inspections .....7-7  
         Annual Inspection.....7-7  
         100-Hour Inspection.....7-7  
         Other Inspection Programs.....7-8  
         Altimeter System Inspection .....7-8  
         Transponder Inspection .....7-8  
         Preflight Inspections.....7-8  
         Minimum Equipment Lists (MEL) and Operations with Inoperative Equipment .....7-8  
     Preventive Maintenance .....7-9  
     Repairs and Alterations .....7-9  
     Special Flight Permits .....7-9

Airworthiness Directives.....7-10  
 Aircraft Owner/Operator Responsibilities.....7-11

**Chapter 8—Weight and Balance**

Weight Control .....8-1  
     Effects of Weight.....8-1  
     Weight Changes.....8-2  
 Balance, Stability, and Center of Gravity.....8-2  
     Effects of Adverse Balance .....8-2  
     Management of Weight and Balance Control.....8-3  
     Terms and Definitions .....8-3  
     Basic Principles of Weight and Balance Computations.....8-4  
     Weight and Balance Restrictions.....8-6  
 Determining Loaded Weight and Center of Gravity.....8-6  
     Computational Method.....8-6  
     Graph Method.....8-6  
     Table Method.....8-8  
     Computations with a Negative Arm.....8-8  
     Computations with Zero Fuel Weight .....8-9  
     Shifting, Adding, and Removing Weight .....8-9  
         Weight Shifting.....8-9  
         Weight Addition or Removal.....8-10

**Chapter 9—Aircraft Performance**

Importance of Performance Data .....9-1  
 Structure of the Atmosphere.....9-1  
     Atmospheric Pressure .....9-1  
     Pressure Altitude.....9-2  
     Density Altitude.....9-3  
         Effects of Pressure on Density .....9-4  
         Effects of Temperature on Density.....9-4  
         Effect of Humidity (Moisture) on Density.....9-4  
 Performance.....9-4  
     Straight-and-Level Flight .....9-5  
     Climb Performance.....9-6  
     Range Performance .....9-8  
     Ground Effect .....9-10  
     Region of Reversed Command .....9-12  
     Runway Surface and Gradient.....9-13  
     Water on the Runway and Dynamic Hydroplaning.....9-14  
     Takeoff and Landing Performance .....9-15  
         Takeoff Performance .....9-15  
         Landing Performance .....9-17  
     Performance Speeds .....9-18  
     Performance Charts .....9-19  
         Interpolation.....9-20  
         Density Altitude Charts .....9-20  
         Takeoff Charts .....9-22  
         Climb and Cruise Charts .....9-23

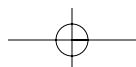



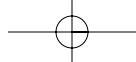

- Crosswind and Headwind
  - Component Chart.....9-28
  - Landing Charts .....9-29
  - Stall Speed Performance Charts .....9-30
- Transport Category Airplane Performance.....9-31
  - Major Differences in Transport Category versus Non-Transport Category Performance Requirements....9-31
  - Performance Requirements .....9-31
  - Runway Requirements.....9-32
  - Balanced Field Length.....9-32
  - Climb Requirements .....9-34
    - First Segment.....9-35
    - Second Segment .....9-35
    - Third or Acceleration Segment .....9-35
    - Forth or Final Segment.....9-35
    - Second Segment Climb Limitations...9-35
  - Air Carrier Obstacle Clearance Requirements .....9-36
  - Summary of Takeoff Requirements.....9-36
  - Landing Performance .....9-37
    - Planning the Landing.....9-37
    - Landing Requirements.....9-37
    - Approach Climb Requirements .....9-37
    - Landing Runway Required.....9-37
    - Summary of Landing Requirements .....9-38
- Examples of Performance Charts .....9-39

**Chapter 10—Weather Theory**

- Nature of the Atmosphere .....10-1
  - Oxygen and the Human Body .....10-2
  - Significance of Atmospheric Pressure....10-3
    - Measurement of Atmospheric Pressure.....10-3
    - Effect of Altitude on Atmospheric Pressure.....10-4
    - Effect of Altitude on Flight .....10-4
    - Effect of Differences in Air Density ..10-5
    - Wind .....10-5
- The Cause of Atmosphere Circulation .....10-5
  - Wind Patterns .....10-6
  - Convective Currents .....10-7
  - Effect of Obstructions on Wind.....10-8
  - Low-Level Wind Shear .....10-9
  - Wind and Pressure Representation on Surface Weather Maps.....10-11
- Atmospheric Stability .....10-12
  - Inversion .....10-13
  - Moisture and Temperature.....10-13
  - Relative Humidity .....10-13
  - Temperature/Dewpoint Relationship....10-13
  - Methods By Which Air Reaches the Saturation Point .....10-14

- Dew and Frost .....10-14
- Fog.....10-14
- Clouds.....10-15
- Ceiling .....10-17
- Visibility .....10-18
- Precipitation.....10-18
- Air Masses .....10-18
- Fronts .....10-18
  - Warm Front.....10-19
    - Flight Toward an Approaching Warm Front.....10-20
  - Cold Front.....10-20
    - Fast-Moving Cold Front.....10-21
    - Flight Toward an Approaching Cold Front.....10-21
    - Comparison of Cold and Warm Fronts .....10-21
- Wind Shifts .....10-21
- Stationary Front .....10-22
- Occluded Front .....10-22

**Chapter 11—Weather Reports, Forecasts, and Charts**

- Observations .....11-1
  - Surface Aviation Weather Observations .....11-1
  - Upper Air Observations .....11-1
  - Radar Observations.....11-2
- Service Outlets.....11-2
  - FAA Flight Service Station.....11-2
  - Transcribed Information Briefing Service (TIBS).....11-2
  - Direct User Access Terminal Service (DUATS).....11-2
  - En Route Flight Advisory Service.....11-2
  - Hazardous In-Flight Weather Advisory (HIWAS).....11-3
  - Transcribed Weather Broadcast (TWEB) .....11-3
- Weather Briefings .....11-3
  - Standard Briefing.....11-3
  - Abbreviated Briefing .....11-4
  - Outlook Briefing.....11-4
- Aviation Weather Reports.....11-4
  - Aviation Routine Weather Report (METAR).....11-4
  - Pilot Weather Reports (PIREPs).....11-7
  - Radar Weather Reports (SD) .....11-8
- Aviation Forecasts .....11-9
  - Terminal Aerodrome Forecasts.....11-9
  - Area Forecasts .....11-10
  - In-Flight Weather Advisories.....11-12
    - Airman’s Meteorological Information (AIRMET).....11-12

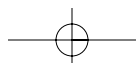

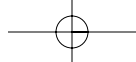

Significant Meteorological Information (SIGMET).....11-12

Convective Significant Meteorological Information (WST) .....11-12

Winds and Temperature Aloft Forecast (FD).....11-13

Weather Charts.....11-14

Surface Analysis Chart .....11-14

Weather Depiction Chart .....11-15

Radar Summary Chart .....11-16

Significant Weather Prognostic Charts .....11-18

**Chapter 12—Airport Operations**

Types of Airports .....12-1

Controlled Airport .....12-1

Uncontrolled Airport .....12-1

Sources for Airport Data .....12-1

Aeronautical Charts .....12-1

Airport/Facility Directory.....12-1

Notices to Airmen.....12-3

Airport Markings and Signs .....12-3

Runway Markings .....12-3

Taxiway Markings .....12-3

Other Markings.....12-3

Airport Signs .....12-3

Airport Lighting.....12-5

Airport Beacon .....12-5

Approach Light Systems .....12-6

Visual Glideslope Indicators .....12-6

Visual Approach Slope Indicator.....12-6

Other Glidepath Systems.....12-6

Runway Lighting .....12-6

Runway End Identifier Lights .....12-6

Runway Edge Lights .....12-7

In-Runway Lighting .....12-7

Control of Airport Lighting.....12-7

Taxiway Lights .....12-8

Obstruction Lights .....12-8

Wind Direction Indicators .....12-8

Radio Communications .....12-8

Radio License .....12-8

Radio Equipment.....12-8

Lost Communication Procedures .....12-9

Air Traffic Control Services .....12-10

Primary Radar.....12-10

Air Traffic Control Radar Beacon System .....12-11

Transponder .....12-11

Radar Traffic Information Service.....12-11

Wake Turbulence .....12-12

Vortex Generation.....12-13

Vortex Strength.....12-13

Vortex Behavior.....12-13

Vortex Avoidance Procedures.....12-13

Collision Avoidance.....12-14

Clearing Procedures.....12-14

Runway Incursion Avoidance.....12-14

**Chapter 13—Airspace**

Controlled Airspace .....13-1

Class A Airspace.....13-1

Class B Airspace.....13-1

Class C Airspace.....13-1

Class D Airspace .....13-3

Class E Airspace.....13-3

Uncontrolled Airspace .....13-3

Class G Airspace .....13-3

Special Use Airspace .....13-3

Prohibited Areas .....13-3

Restricted Areas.....13-3

Warning Areas .....13-4

Military Operation Areas.....13-4

Alert Areas.....13-4

Controlled Firing Areas.....13-4

Other Airspace Areas.....13-4

Airport Advisory Areas .....13-4

Military Training Routes .....13-4

Temporary Flight Restrictions.....13-4

Parachute Jump Areas .....13-4

Published VFR Routes .....13-4

Terminal Radar Service Areas.....13-5

National Security Areas.....13-5

**Chapter 14—Navigation**

Aeronautical Charts .....14-1

Sectional Charts.....14-1

Visual Flight Rule Terminal Area Charts.....14-1

World Aeronautical Charts .....14-1

Latitude and Longitude (Meridians and Parallels) .....14-2

Time Zones .....14-2

Measurement of Direction.....14-3

Variation.....14-4

Deviation .....14-5

Effect of Wind .....14-6

Basic Calculations .....14-8

Converting Minutes to Equivalent Hours .....14-8

Converting Knots to Miles Per Hour .....14-8

Fuel Consumption .....14-8

Flight Computers.....14-8

Plotter.....14-8

Pilotage.....14-10

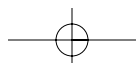

Dead Reckoning .....	14-10	Spatial Disorientation and Illusions .....	15-4
The Wind Triangle or Vector		Motion Sickness .....	15-6
Analysis .....	14-10	Carbon Monoxide Poisoning.....	15-6
Flight Planning .....	14-13	Stress.....	15-6
Assembling Necessary Material.....	14-13	Fatigue .....	15-7
Weather Check.....	14-13	Dehydration and Heatstroke.....	15-7
Use of the Airport/Facility Directory ...	14-13	Alcohol .....	15-8
Airplane Flight Manual or Pilot's		Drugs .....	15-8
Operating Handbook .....	14-13	Scuba Diving .....	15-9
Charting the Course.....	14-14	Vision in Flight.....	15-9
Steps in Charting the Course.....	14-14	Empty-Field Myopia .....	15-10
Filing a VFR Flight Plan .....	14-16	Night Vision.....	15-10
Radio Navigation.....	14-17	Night Vision Illusions.....	15-11
Very High Frequency (VHF)		Autokinesis .....	15-11
Omnidirectional Range (VOR) .....	14-18	False Horizon.....	15-11
Using the VOR .....	14-19	Night Landing Illusions.....	15-12
Tracking with VOR .....	14-20		
Tips On Using the VOR .....	14-21		
Distance Measuring Equipment .....	14-21	<b>Chapter 16—Aeronautical Decision Making</b>	
VOR/DME RNAV .....	14-21	Origins of ADM Training.....	16-2
Automatic Direction Finder .....	14-22	The Decision-Making Process.....	16-2
Loran-C Navigation.....	14-24	Defining the Problem .....	16-2
Global Position System .....	14-26	Choosing a Course of Action .....	16-3
Lost Procedures .....	14-27	Implementing the Decision and	
Flight Diversion.....	14-27	Evaluating the Outcome .....	16-4
		Risk Management.....	16-4
		Assessing Risk.....	16-5
		Factors Affecting Decision Making .....	16-5
<b>Chapter 15—Aeromedical Factors</b>		Pilot Self-Assessment.....	16-5
Obtaining a Medical Certificate .....	15-1	Recognizing Hazardous Attitudes .....	16-6
Environmental and Health Factors		Stress Management.....	16-6
Affecting Pilot Performance.....	15-2	Use of Resources .....	16-7
Hypoxia .....	15-2	Internal Resources .....	16-7
Hypoxic Hypoxia.....	15-2	External Resources .....	16-8
Hypemic Hypoxia.....	15-2	Workload Management.....	16-8
Stagnant Hypoxia .....	15-2	Situational Awareness.....	16-8
Histotoxic Hypoxia.....	15-2	Obstacles to Maintaining Situational	
Symptoms of Hypoxia.....	15-2	Awareness .....	16-9
Hyperventilation .....	15-3	Operational Pitfalls.....	16-9
Middle Ear and Sinus Problems .....	15-3		

# Chapter 1



## Aircraft Structure

According to the current Title 14 of the Code of Federal Regulations (14 CFR) part 1, Definitions and Abbreviations, an **aircraft** is a device that is used, or intended to be used, for flight. Categories of aircraft for certification of airmen include airplane, rotorcraft, lighter-than-air, powered-lift, and glider. Part 1 also defines **airplane** as an engine-driven, fixed-wing aircraft heavier than air that is supported in flight by the dynamic reaction of air against its wings. This chapter

**Aircraft**—A device that is used for flight in the air.

**Airplane**—An engine-driven, fixed-wing aircraft heavier than air that is supported in flight by the dynamic reaction of air against its wings.

provides a brief introduction to the airplane and its major components.

### MAJOR COMPONENTS

Although airplanes are designed for a variety of purposes, most of them have the same major components. The overall characteristics are largely determined by the original design objectives. Most airplane structures include a fuselage, wings, an empennage, landing gear, and a powerplant. [Figure 1-1]

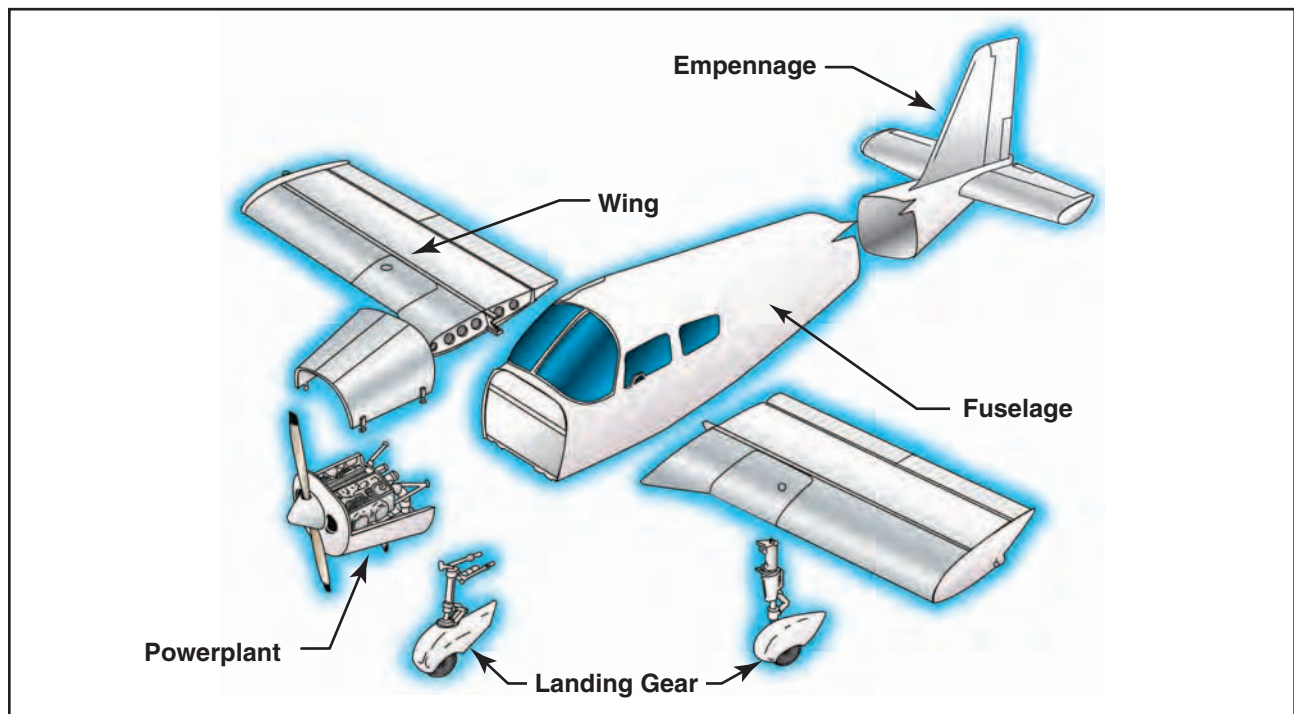

Figure 1-1. Airplane components.



## FUSELAGE

The fuselage includes the cabin and/or cockpit, which contains seats for the occupants and the controls for the airplane. In addition, the fuselage may also provide room for cargo and attachment points for the other major airplane components. Some aircraft utilize an open **truss** structure. The truss-type fuselage is constructed of steel or aluminum tubing. Strength and rigidity is achieved by welding the tubing together into a series of triangular shapes, called trusses. [Figure 1-2]

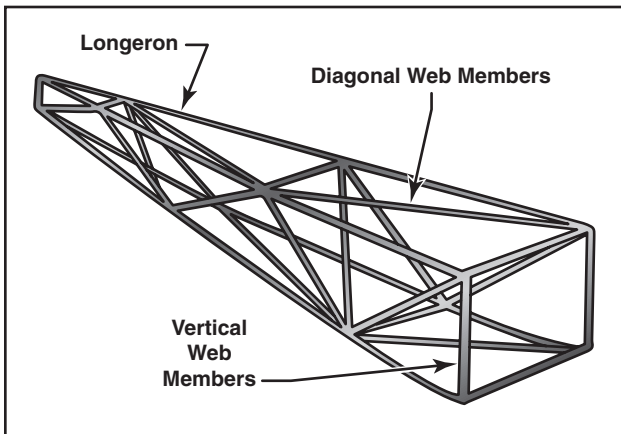

Figure 1-2. The Warren truss.

Construction of the Warren truss features longerons, as well as diagonal and vertical web members. To reduce weight, small airplanes generally utilize aluminum alloy tubing, which may be riveted or bolted into one piece with cross-bracing members.

As technology progressed, aircraft designers began to enclose the truss members to streamline the airplane and improve performance. This was originally accomplished with cloth fabric, which eventually gave way to lightweight metals such as aluminum. In some cases, the outside skin can support all or a major portion of the flight loads. Most modern aircraft use a form of this stressed skin structure known as monocoque or semi-monocoque construction.

The **monocoque** design uses stressed skin to support almost all imposed loads. This structure can be very strong but cannot tolerate dents or deformation of the surface. This characteristic is easily demonstrated by a thin aluminum beverage can. You can exert considerable force to the ends of the can without causing any damage.

**Truss**—A fuselage design made up of supporting structural members that resist deformation by applied loads.

**Monocoque**—A shell-like fuselage design in which the stressed outer skin is used to support the majority of imposed stresses. Monocoque fuselage design may include bulkheads but not stringers.

However, if the side of the can is dented only slightly, the can will collapse easily. The true monocoque construction mainly consists of the skin, formers, and bulkheads. The formers and bulkheads provide shape for the fuselage. [Figure 1-3]

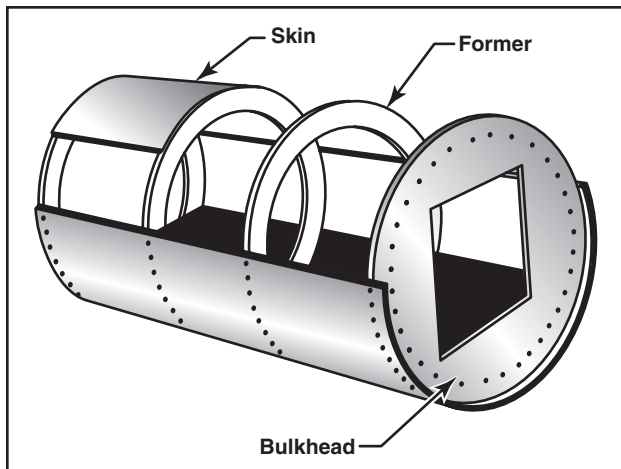

Figure 1-3. Monocoque fuselage design.

Since no bracing members are present, the skin must be strong enough to keep the fuselage rigid. Thus, a significant problem involved in monocoque construction is maintaining enough strength while keeping the weight within allowable limits. Due to the limitations of the monocoque design, a semi-monocoque structure is used on many of today's aircraft.

The **semi-monocoque** system uses a substructure to which the airplane's skin is attached. The substructure, which consists of bulkheads and/or formers of various sizes and stringers, reinforces the stressed skin by taking some of the bending stress from the fuselage. The main section of the fuselage also includes wing attachment points and a firewall. [Figure 1-4]

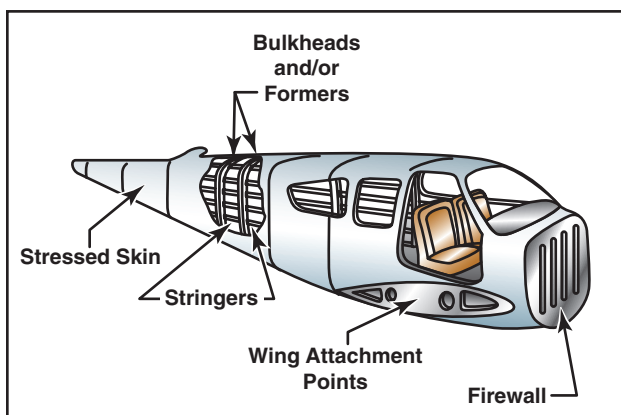

Figure 1-4. Semi-monocoque construction.

**Semi-Monocoque**—A fuselage design that includes a substructure of bulkheads and/or formers, along with stringers, to support flight loads and stresses imposed on the fuselage.

On single-engine airplanes, the engine is usually attached to the front of the fuselage. There is a fireproof partition between the rear of the engine and the cockpit or cabin to protect the pilot and passengers from accidental engine fires. This partition is called a firewall and is usually made of heat-resistant material such as stainless steel.

## WINGS

The wings are **airfoils** attached to each side of the fuselage and are the main lifting surfaces that support the airplane in flight. There are numerous wing designs, sizes, and shapes used by the various manufacturers. Each fulfills a certain need with respect to the expected performance for the particular airplane. How the wing produces lift is explained in subsequent chapters.

Wings may be attached at the top, middle, or lower portion of the fuselage. These designs are referred to as high-, mid-, and low-wing, respectively. The number of wings can also vary. Airplanes with a single set of wings are referred to as **monoplanes**, while those with two sets are called **biplanes**. [Figure 1-5]

Many high-wing airplanes have external braces, or wing struts, which transmit the flight and landing loads

**Airfoil**—An airfoil is any surface, such as a wing, propeller, rudder, or even a trim tab, which provides aerodynamic force when it interacts with a moving stream of air.

**Monoplane**—An airplane that has only one main lifting surface or wing, usually divided into two parts by the fuselage.

**Biplane**—An airplane that has two main airfoil surfaces or wings on each side of the fuselage, one placed above the other.

through the struts to the main fuselage structure. Since the wing struts are usually attached approximately halfway out on the wing, this type of wing structure is called semi-cantilever. A few high-wing and most low-wing airplanes have a full cantilever wing designed to carry the loads without external struts.



Figure 1-5. Monoplane and biplane.

The principal structural parts of the wing are spars, ribs, and stringers. [Figure 1-6] These are reinforced by

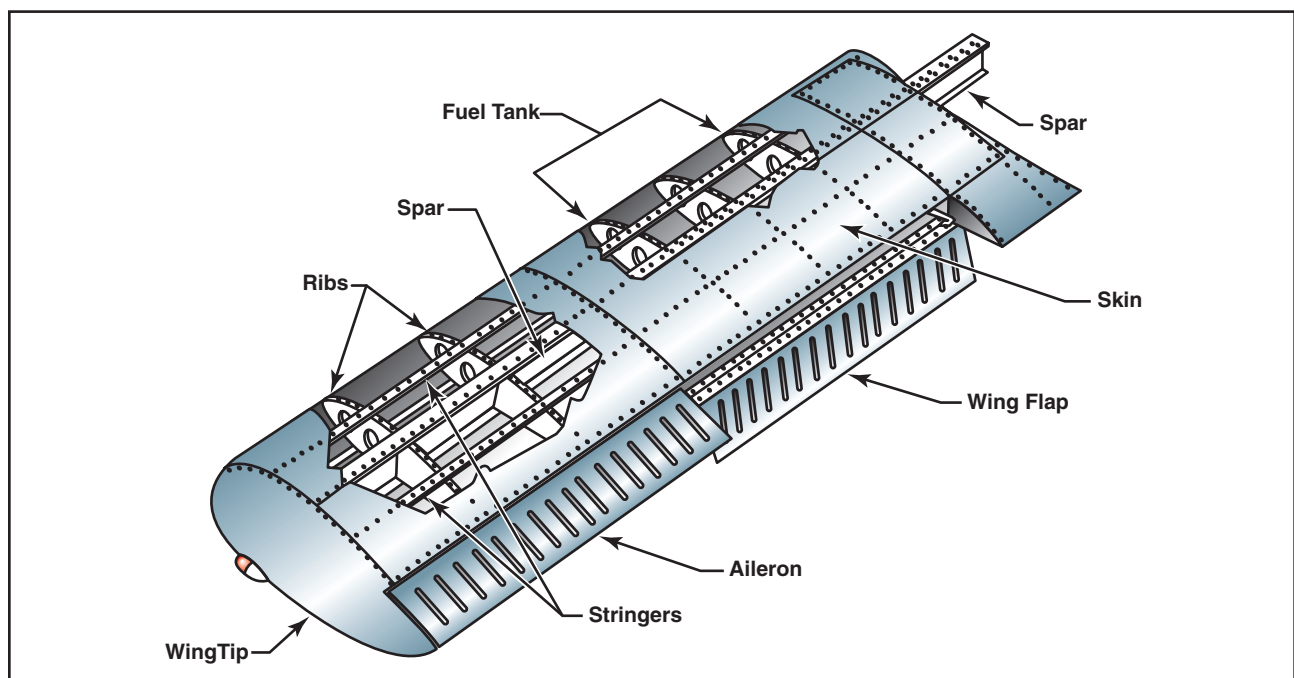

Figure 1-6. Wing components.



trusses, I-beams, tubing, or other devices, including the skin. The wing ribs determine the shape and thickness of the wing (airfoil). In most modern airplanes, the fuel tanks either are an integral part of the wing's structure, or consist of flexible containers mounted inside of the wing.

Attached to the rear, or trailing, edges of the wings are two types of control surfaces referred to as ailerons and flaps. Ailerons extend from about the midpoint of each wing outward toward the tip and move in opposite directions to create aerodynamic forces that cause the airplane to roll. Flaps extend outward from the fuselage to near the midpoint of each wing. The flaps are normally flush with the wing's surface during cruising flight. When extended, the flaps move simultaneously downward to increase the lifting force of the wing for takeoffs and landings.

## EMPENNAGE

The correct name for the tail section of an airplane is empennage. The **empennage** includes the entire tail group, consisting of fixed surfaces such as the vertical stabilizer and the horizontal stabilizer. The movable surfaces include the rudder, the elevator, and one or more trim tabs. [Figure 1-7]

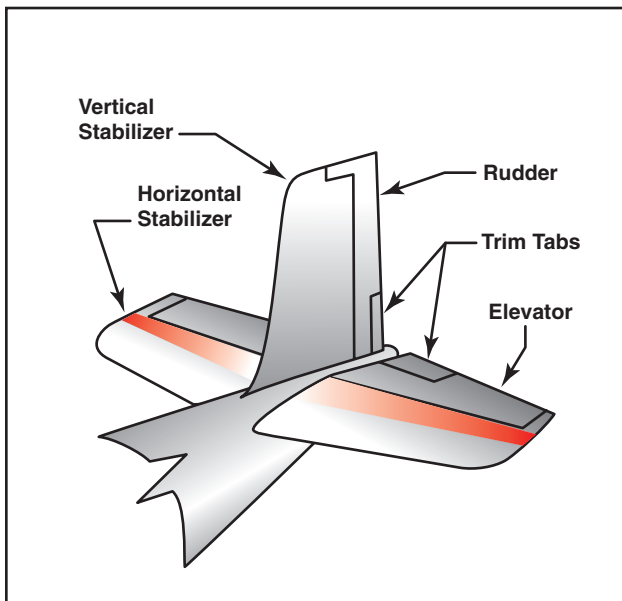

Figure 1-7. Empennage components.

**Empennage**—The section of the airplane that consists of the vertical stabilizer, the horizontal stabilizer, and the associated control surfaces.

A second type of empennage design does not require an elevator. Instead, it incorporates a one-piece horizontal stabilizer that pivots from a central hinge point. This type of design is called a stabilator, and is moved using the control wheel, just as you would the elevator. For example, when you pull back on the control wheel, the stabilator pivots so the trailing edge moves up. This increases the aerodynamic tail load and causes the nose of the airplane to move up. Stabilators have an antiservo tab extending across their trailing edge. [Figure 1-8]

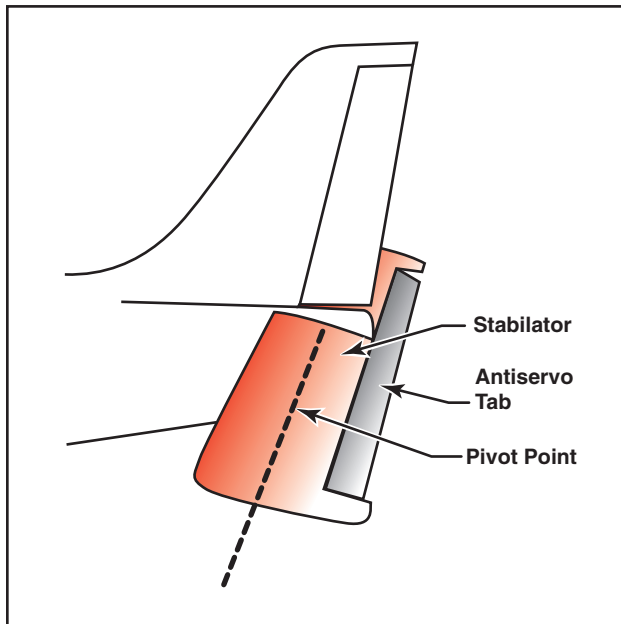

Figure 1-8. Stabilator components.

The antiservo tab moves in the same direction as the trailing edge of the stabilator. The antiservo tab also functions as a trim tab to relieve control pressures and helps maintain the stabilator in the desired position.

The rudder is attached to the back of the vertical stabilizer. During flight, it is used to move the airplane's nose left and right. The rudder is used in combination with the ailerons for turns during flight. The elevator, which is attached to the back of the horizontal stabilizer, is used to move the nose of the airplane up and down during flight.

Trim tabs are small, movable portions of the trailing edge of the control surface. These movable trim tabs, which are controlled from the cockpit, reduce control pressures. Trim tabs may be installed on the ailerons, the rudder, and/or the elevator.

## LANDING GEAR

The landing gear is the principle support of the airplane when parked, taxiing, taking off, or when landing. The

most common type of landing gear consists of wheels, but airplanes can also be equipped with floats for water operations, or skis for landing on snow. [Figure 1-9]



Figure 1-9. Landing gear.

The landing gear consists of three wheels—two main wheels and a third wheel positioned either at the front or rear of the airplane. Landing gear employing a rear-mounted wheel is called conventional landing gear. Airplanes with conventional landing gear are sometimes referred to as tailwheel airplanes. When the third wheel is located on the nose, it is called a nosewheel, and the design is referred to as a tricycle gear. A steerable nosewheel or tailwheel permits the airplane to be controlled throughout all operations while on the ground.

### THE POWERPLANT

The powerplant usually includes both the engine and the propeller. The primary function of the engine is to provide the power to turn the propeller. It also generates electrical power, provides a vacuum source for some flight instruments, and in most single-engine

airplanes, provides a source of heat for the pilot and passengers. The engine is covered by a cowling, or in the case of some airplanes, surrounded by a **nacelle**. The purpose of the cowling or nacelle is to streamline the flow of air around the engine and to help cool the engine by ducting air around the cylinders. The propeller, mounted on the front of the engine, translates the rotating force of the engine into a forward-acting force called thrust that helps move the airplane through the air. [Figure 1-10]

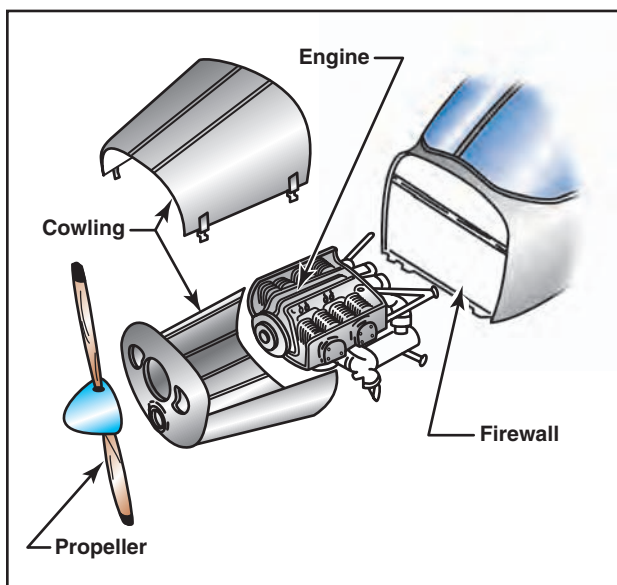
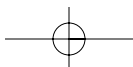
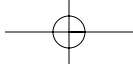
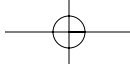

Figure 1-10. Engine compartment.

**Nacelle**—A streamlined enclosure on an aircraft in which an engine is mounted. On multiengine propeller-driven airplanes, the nacelle is normally mounted on the leading edge of the wing.





## Chapter 2

# Principles of Flight

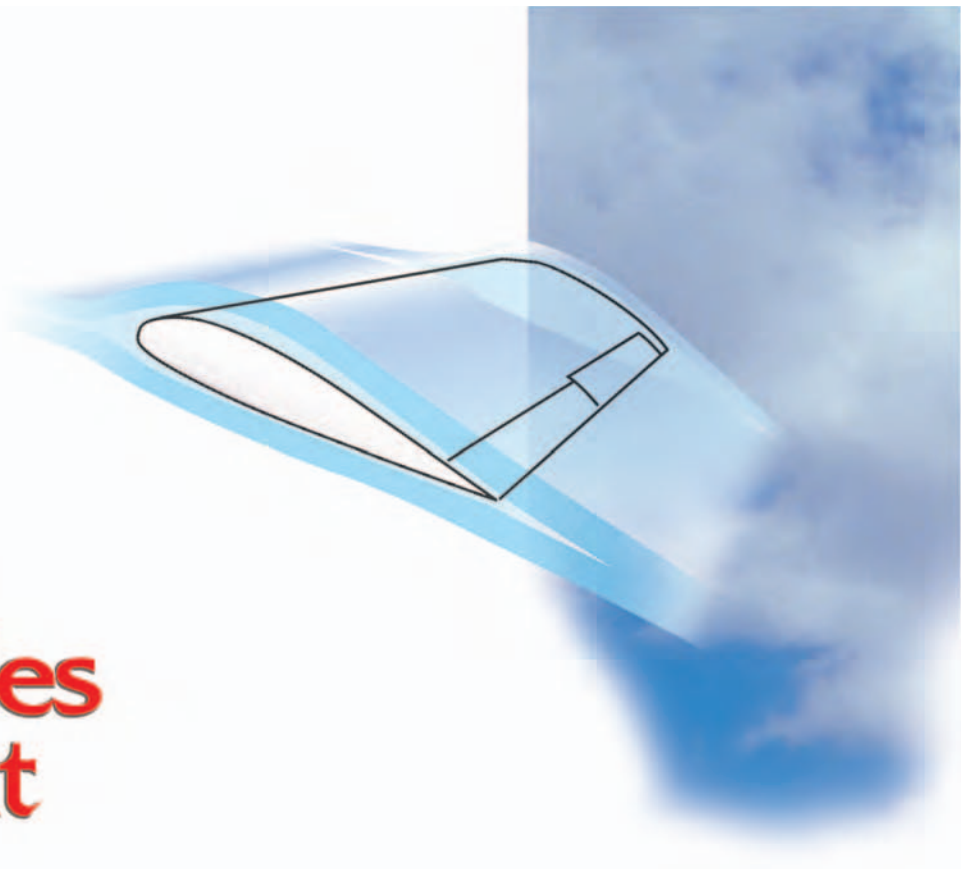

This chapter discusses the fundamental physical laws governing the forces acting on an airplane in flight, and what effect these natural laws and forces have on the performance characteristics of airplanes. To competently control the airplane, the pilot must understand the principles involved and learn to utilize or counteract these natural forces.

Modern general aviation airplanes have what may be considered high performance characteristics. Therefore, it is increasingly necessary that pilots appreciate and understand the principles upon which the art of flying is based.

### **STRUCTURE OF THE ATMOSPHERE**

The atmosphere in which flight is conducted is an envelope of air that surrounds the earth and rests upon its surface. It is as much a part of the earth as the seas or the land. However, air differs from land and water inasmuch as it is a mixture of gases. It has mass, weight, and indefinite shape.

Air, like any other fluid, is able to flow and change its shape when subjected to even minute pressures because of the lack of strong molecular cohesion. For example, gas will completely fill any container into which it is placed, expanding or contracting to adjust its shape to the limits of the container.

The atmosphere is composed of 78 percent nitrogen, 21 percent oxygen, and 1 percent other gases, such as argon or helium. As some of these elements are heavier than others, there is a natural tendency of these heavier elements, such as oxygen, to settle to the surface of the earth, while the lighter elements are lifted up to the region of higher altitude. This explains why most of the oxygen is contained below 35,000 feet altitude.

Because air has mass and weight, it is a body, and as a body, it reacts to the scientific laws of bodies in the same manner as other gaseous bodies. This body of air resting upon the surface of the earth has weight and at sea level develops an average pressure of 14.7 pounds on each square inch of surface, or 29.92 inches of

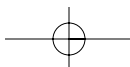

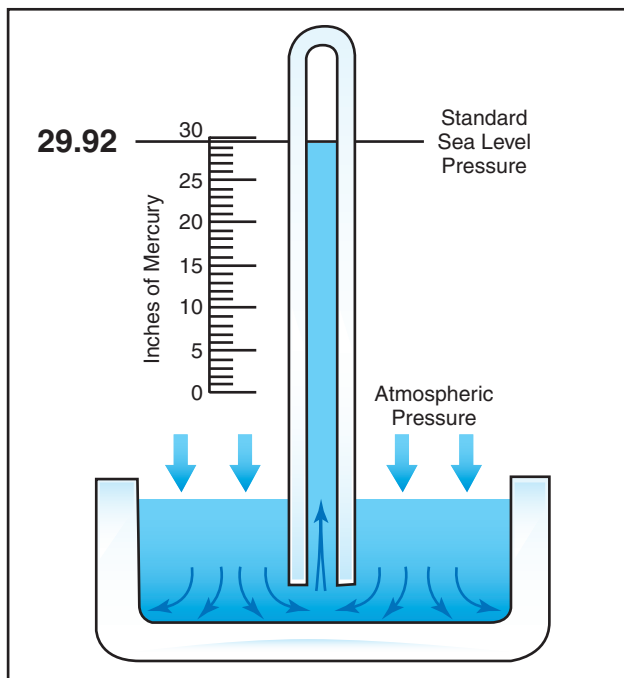

Figure 2-1. Standard sea level pressure.

mercury—but as its thickness is limited, the higher the altitude, the less air there is above. For this reason, the weight of the atmosphere at 18,000 feet is only one-half what it is at sea level. [Figure 2-1]

## ATMOSPHERIC PRESSURE

Though there are various kinds of pressure, this discussion is mainly concerned with atmospheric pressure. It is one of the basic factors in weather changes, helps to lift the airplane, and actuates some of the important flight instruments in the airplane. These instruments are the altimeter, the airspeed indicator, the rate-of-climb indicator, and the manifold pressure gauge.

Though air is very light, it has mass and is affected by the attraction of gravity. Therefore, like any other substance, it has weight, and because of its weight, it has force. Since it is a fluid substance, this force is exerted equally in all directions, and its effect on bodies within the air is called pressure. Under standard conditions at sea level, the average pressure exerted on the human body by the weight of the atmosphere around it is approximately 14.7 lb./in. The density of air has significant effects on the airplane's capability. As air becomes less dense, it reduces (1) power because the engine takes in less air, (2) thrust because the propeller is less efficient in thin air, and (3) lift because the thin air exerts less force on the airfoils.

## EFFECTS OF PRESSURE ON DENSITY

Since air is a gas, it can be compressed or expanded. When air is compressed, a greater amount of air can

occupy a given volume. Conversely, when pressure on a given volume of air is decreased, the air expands and occupies a greater space. That is, the original column of air at a lower pressure contains a smaller mass of air. In other words, the density is decreased. In fact, density is directly proportional to pressure. If the pressure is doubled, the density is doubled, and if the pressure is lowered, so is the density. This statement is true, only at a constant temperature.

## EFFECT OF TEMPERATURE ON DENSITY

The effect of increasing the temperature of a substance is to decrease its density. Conversely, decreasing the temperature has the effect of increasing the density. Thus, the density of air varies inversely as the absolute temperature varies. This statement is true, only at a constant pressure.

In the atmosphere, both temperature and pressure decrease with altitude, and have conflicting effects upon density. However, the fairly rapid drop in pressure as altitude is increased usually has the dominating effect. Hence, density can be expected to decrease with altitude.

## EFFECT OF HUMIDITY ON DENSITY

The preceding paragraphs have assumed that the air was perfectly dry. In reality, it is never completely dry. The small amount of water vapor suspended in the atmosphere may be almost negligible under certain conditions, but in other conditions humidity may become an important factor in the performance of an airplane. Water vapor is lighter than air; consequently, moist air is lighter than dry air. It is lightest or least dense when, in a given set of conditions, it contains the maximum amount of water vapor. The higher the temperature, the greater amount of water vapor the air can hold. When comparing two separate air masses, the first warm and moist (both qualities tending to lighten the air) and the second cold and dry (both qualities making it heavier), the first necessarily must be less dense than the second. Pressure, temperature, and humidity have a great influence on airplane performance, because of their effect upon density.

## NEWTON'S LAWS OF MOTION AND FORCE

In the 17th century, a philosopher and mathematician, Sir Isaac Newton, propounded three basic laws of motion. It is certain that he did not have the airplane in mind when he did so, but almost everything known about motion goes back to his three simple laws. These laws, named after Newton, are as follows:

**Newton's first law** states, in part, that: A body at rest tends to remain at rest, and a body in motion tends to



remain moving at the same speed and in the same direction.

This simply means that, in nature, nothing starts or stops moving until some outside force causes it to do so. An airplane at rest on the ramp will remain at rest unless a force strong enough to overcome its inertia is applied. Once it is moving, however, its inertia keeps it moving, subject to the various other forces acting on it. These forces may add to its motion, slow it down, or change its direction.

**Newton's second law** implies that: When a body is acted upon by a constant force, its resulting acceleration is inversely proportional to the mass of the body and is directly proportional to the applied force.

What is being dealt with here are the factors involved in overcoming Newton's First Law of Inertia. It covers both changes in direction and speed, including starting up from rest (positive acceleration) and coming to a stop (negative acceleration, or deceleration).

**Newton's third law** states that: Whenever one body exerts a force on another, the second body always exerts on the first, a force that is equal in magnitude but opposite in direction.

The recoil of a gun as it is fired is a graphic example of Newton's third law. The champion swimmer who pushes against the side of the pool during the turnaround, or the infant learning to walk—both would fail but for the phenomena expressed in this law. In an airplane, the propeller moves and pushes back the air; consequently, the air pushes the propeller (and thus the airplane) in the opposite direction—forward. In a jet airplane, the engine pushes a blast of hot gases backward; the force of equal and opposite reaction pushes against the engine and forces the airplane forward. The movement of all vehicles is a graphic illustration of Newton's third law.

## MAGNUS EFFECT

The explanation of lift can best be explained by looking at a cylinder rotating in an airstream. The local velocity near the cylinder is composed of the airstream velocity and the cylinder's rotational velocity, which decreases with distance from the cylinder. On a cylinder, which is rotating in such a way that the top surface area is rotating in the same direction as the airflow, the local velocity at the surface is high on top and low on the bottom.

As shown in figure 2-2, at point "A," a stagnation point exists where the airstream line that impinges on the surface splits; some air goes over and some under. Another stagnation point exists at "B," where the two

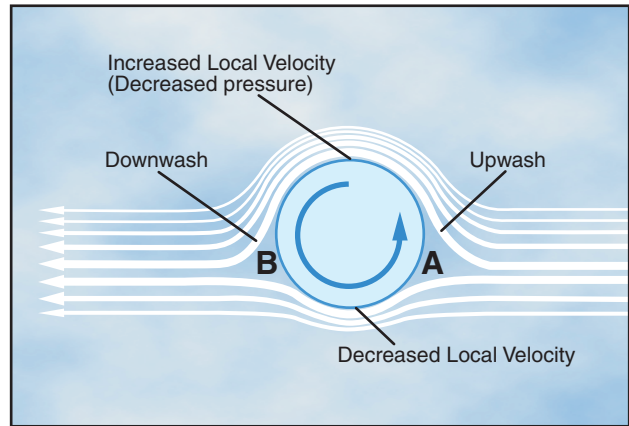
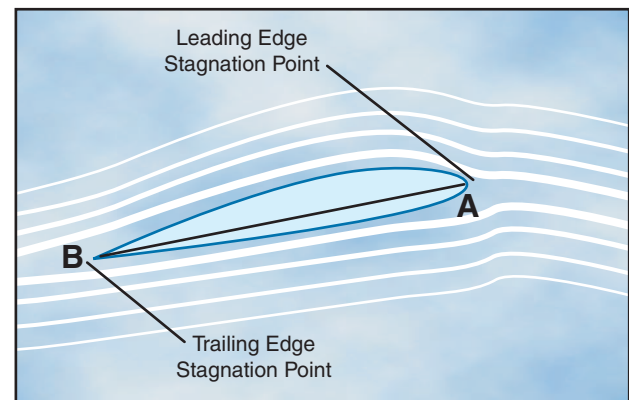

**Figure 2-2. Magnus Effect is a lifting force produced when a rotating cylinder produces a pressure differential. This is the same effect that makes a baseball curve or a golf ball slice.**

airstreams rejoin and resume at identical velocities. We now have upwash ahead of the rotating cylinder and downwash at the rear.

The difference in surface velocity accounts for a difference in pressure, with the pressure being lower on the top than the bottom. This low pressure area produces an upward force known as the "Magnus Effect." This mechanically induced circulation illustrates the relationship between circulation and lift.

An airfoil with a positive angle of attack develops air circulation as its sharp trailing edge forces the rear stagnation point to be aft of the trailing edge, while the front stagnation point is below the leading edge. [Figure 2-3]

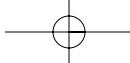

**Figure 2-3. Air circulation around an airfoil occurs when the front stagnation point is below the leading edge and the aft stagnation point is beyond the trailing edge.**

## BERNOULLI'S PRINCIPLE OF PRESSURE

A half century after Sir Newton presented his laws, Mr. Daniel Bernoulli, a Swiss mathematician, explained how the pressure of a moving fluid (liquid or gas) varies with its speed of motion. Specifically,





he stated that an increase in the speed of movement or flow would cause a decrease in the fluid's pressure. This is exactly what happens to air passing over the curved top of the airplane wing.

An appropriate analogy can be made with water flowing through a garden hose. Water moving through a hose of constant diameter exerts a uniform pressure on the hose; but if the diameter of a section of the hose is increased or decreased, it is certain to change the pressure of the water at that point. Suppose the hose was pinched, thereby constricting the area through which the water flows. Assuming that the same volume of water flows through the constricted portion of the hose in the same period of time as before the hose was pinched, it follows that the speed of flow must increase at that point.

Therefore, if a portion of the hose is constricted, it not only increases the speed of the flow, but also decreases the pressure at that point. Like results could be achieved if streamlined solids (airfoils) were introduced at the same point in the hose. This same principle is the basis for the measurement of airspeed (fluid flow) and for analyzing the airfoil's ability to produce lift.

A practical application of Bernoulli's theorem is the venturi tube. The venturi tube has an air inlet which narrows to a throat (constricted point) and an outlet section which increases in diameter toward the rear. The diameter of the outlet is the same as that of the inlet. At the throat, the airflow speeds up and the pressure decreases; at the outlet, the airflow slows and the pressure increases. [Figure 2-4]

If air is recognized as a body and it is accepted that it must follow the above laws, one can begin to see how and why an airplane wing develops lift as it moves through the air.

## AIRFOIL DESIGN

In the sections devoted to Newton's and Bernoulli's discoveries, it has already been discussed in general

terms the question of how an airplane wing can sustain flight when the airplane is heavier than air. Perhaps the explanation can best be reduced to its most elementary concept by stating that lift (flight) is simply the result of fluid flow (air) about an airfoil—or in everyday language, the result of moving an airfoil (wing), by whatever means, through the air.

Since it is the airfoil which harnesses the force developed by its movement through the air, a discussion and explanation of this structure, as well as some of the material presented in previous discussions on Newton's and Bernoulli's laws, will be presented.

An airfoil is a structure designed to obtain reaction upon its surface from the air through which it moves or that moves past such a structure. Air acts in various ways when submitted to different pressures and velocities; but this discussion will be confined to the parts of an airplane that a pilot is most concerned with in flight—namely, the airfoils designed to produce lift. By looking at a typical airfoil profile, such as the cross section of a wing, one can see several obvious characteristics of design. [Figure 2-5] Notice that there is a difference in the curvatures of the upper and lower surfaces of the airfoil (the curvature is called camber). The camber of the upper surface is more pronounced than that of the lower surface, which is somewhat flat in most instances.

In figure 2-5, note that the two extremities of the airfoil profile also differ in appearance. The end which faces forward in flight is called the leading edge, and is rounded; while the other end, the trailing edge, is quite narrow and tapered.

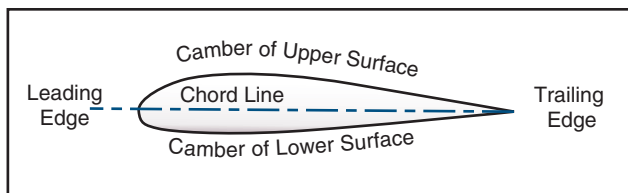

Figure 2-5. Typical airfoil section.

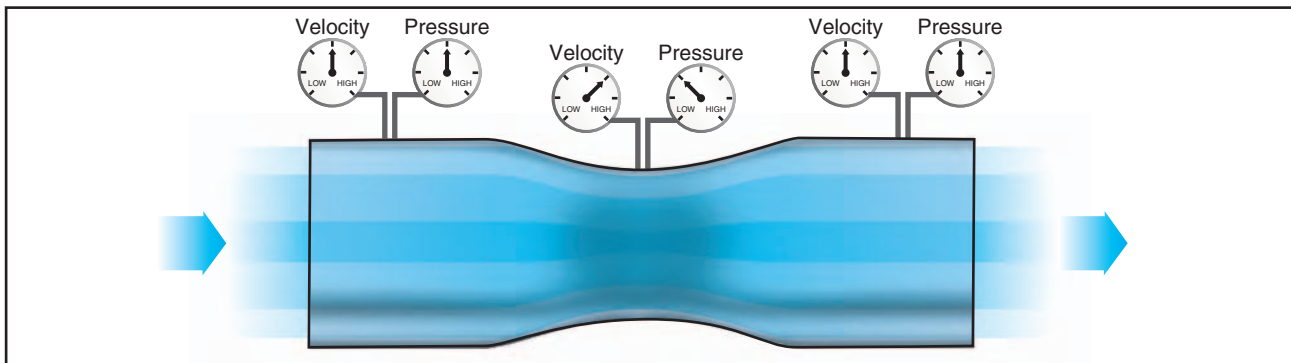
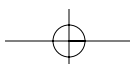

Figure 2-4. Air pressure decreases in a venturi.



A reference line often used in discussing the airfoil is the chord line, a straight line drawn through the profile connecting the extremities of the leading and trailing edges. The distance from this chord line to the upper and lower surfaces of the wing denotes the magnitude of the upper and lower camber at any point. Another reference line, drawn from the leading edge to the trailing edge, is the “mean camber line.” This mean line is equidistant at all points from the upper and lower contours.

The construction of the wing, so as to provide actions greater than its weight, is done by shaping the wing so that advantage can be taken of the air’s response to certain physical laws, and thus develop two actions from the air mass; a positive pressure lifting action from the air mass below the wing, and a negative pressure lifting action from lowered pressure above the wing.

As the airstream strikes the relatively flat lower surface of the wing when inclined at a small angle to its direction of motion, the air is forced to rebound downward and therefore causes an upward reaction in positive lift, while at the same time airstream striking the upper curved section of the “leading edge” of the wing is deflected upward. In other words, a wing shaped to cause an action on the air, and forcing it downward, will provide an equal reaction from the air, forcing the wing upward. If a wing is constructed in such form that it will cause a lift force greater than the weight of the airplane, the airplane will fly.

However, if all the lift required were obtained merely from the deflection of air by the lower surface of the wing, an airplane would need only a flat wing like a kite. This, of course, is not the case at all; under certain conditions disturbed air currents circulating at the trailing edge of the wing could be so excessive as to make the airplane lose speed and lift. The balance of the lift needed to support the airplane comes from the flow of air above the wing. Herein lies the key to flight. The fact that most lift is the result of the airflow’s downwash from above the wing, must be thoroughly understood in order to continue further in the study of flight. It is neither accurate nor does it serve a useful purpose, however, to assign specific values to the percentage of lift generated by the upper surface of an airfoil versus that generated by the lower surface. These are not constant values and will vary, not only with flight conditions, but with different wing designs.

It should be understood that different airfoils have different flight characteristics. Many thousands of airfoils have been tested in wind tunnels and in actual flight, but no one airfoil has been found that satisfies every flight requirement. The weight, speed, and

purpose of each airplane dictate the shape of its airfoil. It was learned many years ago that the most efficient airfoil for producing the greatest lift was one that had a concave, or “scooped out” lower surface. Later it was also learned that as a fixed design, this type of airfoil sacrificed too much speed while producing lift and, therefore, was not suitable for high-speed flight. It is interesting to note, however, that through advanced progress in engineering, today’s high-speed jets can again take advantage of the concave airfoil’s high lift characteristics. Leading edge (Kreuger) flaps and trailing edge (Fowler) flaps, when extended from the basic wing structure, literally change the airfoil shape into the classic concave form, thereby generating much greater lift during slow flight conditions.

On the other hand, an airfoil that is perfectly streamlined and offers little wind resistance sometimes does not have enough lifting power to take the airplane off the ground. Thus, modern airplanes have airfoils which strike a medium between extremes in design, the shape varying according to the needs of the airplane for which it is designed. Figure 2-6 shows some of the more common airfoil sections.

## LOW PRESSURE ABOVE

In a wind tunnel or in flight, an airfoil is simply a streamlined object inserted into a moving stream of air. If the airfoil profile were in the shape of a teardrop, the speed and the pressure changes of the air passing over the top and bottom would be the same on both sides. But if the teardrop shaped airfoil were cut in half lengthwise, a form resembling the basic airfoil (wing) section would result. If the airfoil were then inclined so the airflow strikes it at an angle (angle of attack), the air molecules moving over the upper surface would be forced to move faster than would the molecules moving along the bottom of the airfoil, since the upper molecules must travel a greater distance due to the curvature of the upper surface. This increased velocity reduces the pressure above the airfoil.

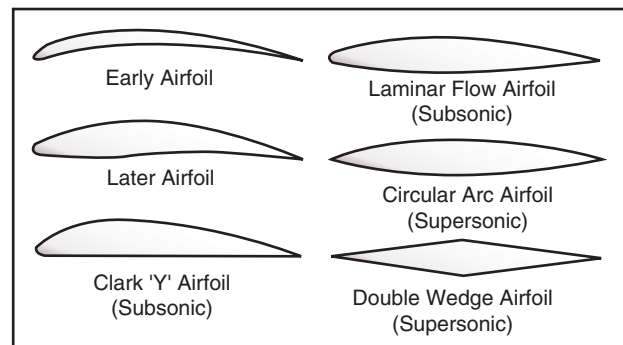

Figure 2-6. Airfoil designs.

Bernoulli's principle of pressure by itself does not explain the distribution of pressure over the upper surface of the airfoil. A discussion of the influence of momentum of the air as it flows in various curved paths near the airfoil will be presented. [Figure 2-7] Momentum is the resistance a moving body offers to having its direction or amount of motion changed. When a body is forced to move in a circular path, it offers resistance in the direction away from the center of the curved path. This is "centrifugal force." While the particles of air move in the curved path AB, centrifugal force tends to throw them in the direction of the arrows between A and B and hence, causes the air to exert more than normal pressure on the leading edge of the airfoil. But after the air particles pass B (the point of reversal of the curvature of the path) the centrifugal force tends to throw them in the direction of the arrows between B and C (causing reduced pressure on the airfoil). This effect is held until the particles reach C, the second point of reversal of curvature of the airflow. Again the centrifugal force is reversed and the particles may even tend to give slightly more than normal pressure on the trailing edge of the airfoil, as indicated by the short arrows between C and D.

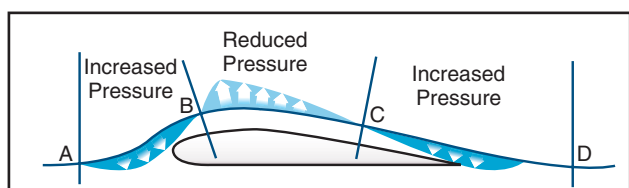

Figure 2-7. Momentum influences airflow over an airfoil.

Therefore, the air pressure on the upper surface of the airfoil is distributed so that the pressure is much greater on the leading edge than the surrounding atmospheric pressure, causing strong resistance to forward motion; but the air pressure is less than surrounding atmospheric pressure over a large portion of the top surface (B to C).

As seen in the application of Bernoulli's theorem to a venturi, the speedup of air on the top of an airfoil produces a drop in pressure. This lowered pressure is a component of total lift. It is a mistake, however, to assume that the pressure difference between the upper and lower surface of a wing alone accounts for the total lift force produced.

One must also bear in mind that associated with the lowered pressure is downwash; a downward backward flow from the top surface of the wing. As already seen from previous discussions relative to the dynamic action of the air as it strikes the lower surface of the wing, the reaction of this downward backward flow

results in an upward forward force on the wing. This same reaction applies to the flow of air over the top of the airfoil as well as to the bottom, and Newton's third law is again in the picture.

## HIGH PRESSURE BELOW

In the section dealing with Newton's laws as they apply to lift, it has already been discussed how a certain amount of lift is generated by pressure conditions underneath the wing. Because of the manner in which air flows underneath the wing, a positive pressure results, particularly at higher angles of attack. But there is another aspect to this airflow that must be considered. At a point close to the leading edge, the airflow is virtually stopped (stagnation point) and then gradually increases speed. At some point near the trailing edge, it has again reached a velocity equal to that on the upper surface. In conformance with Bernoulli's principles, where the airflow was slowed beneath the wing, a positive upward pressure was created against the wing; i.e., as the fluid speed decreases, the pressure must increase. In essence, this simply "accentuates the positive" since it increases the pressure differential between the upper and lower surface of the airfoil, and therefore increases total lift over that which would have resulted had there been no increase of pressure at the lower surface. Both Bernoulli's principle and Newton's laws are in operation whenever lift is being generated by an airfoil.

Fluid flow or airflow then, is the basis for flight in airplanes, and is a product of the velocity of the airplane. The velocity of the airplane is very important to the pilot since it affects the lift and drag forces of the airplane. The pilot uses the velocity (airspeed) to fly at a minimum glide angle, at maximum endurance, and for a number of other flight maneuvers. Airspeed is the velocity of the airplane relative to the air mass through which it is flying.

## PRESSURE DISTRIBUTION

From experiments conducted on wind tunnel models and on full size airplanes, it has been determined that as air flows along the surface of a wing at different angles of attack, there are regions along the surface where the pressure is negative, or less than atmospheric, and regions where the pressure is positive, or greater than atmospheric. This negative pressure on the upper surface creates a relatively larger force on the wing than is caused by the positive pressure resulting from the air striking the lower wing surface. Figure 2-8 shows the pressure distribution along an airfoil at three different angles of attack. In general, at high angles of attack the

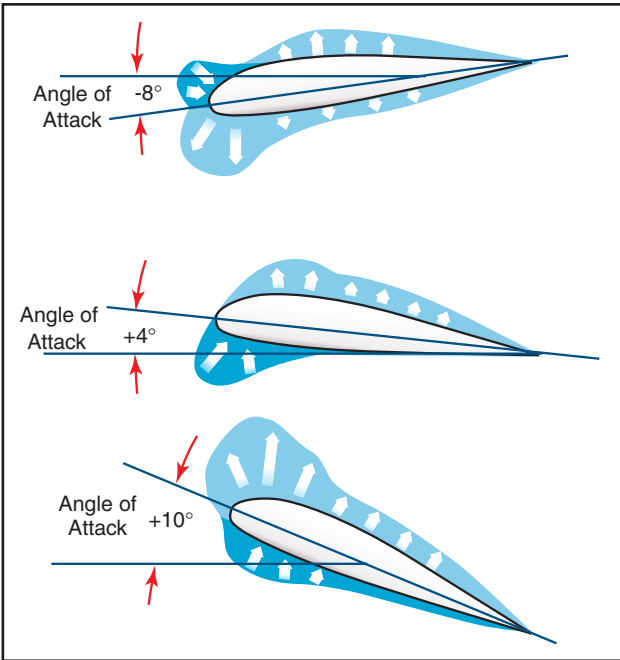

Figure 2-8. Pressure distribution on an airfoil.

center of pressure moves forward, while at low angles of attack the center of pressure moves aft. In the design of wing structures, this center of pressure travel is very important, since it affects the position of the airloads imposed on the wing structure in low angle-of-attack conditions and high angle-of-attack conditions. The airplane's aerodynamic balance and controllability are governed by changes in the center of pressure.

The center of pressure is determined through calculation and wind tunnel tests by varying the airfoil's angle of attack through normal operating extremes. As the angle of attack is changed, so are the various pressure distribution characteristics. [Figure 2-8] Positive (+) and negative (-) pressure forces are totaled for each angle of attack and the resultant force is obtained. The total resultant pressure is represented by the resultant force vector shown in figure 2-9.

The point of application of this force vector is termed the "center of pressure" (CP). For any given

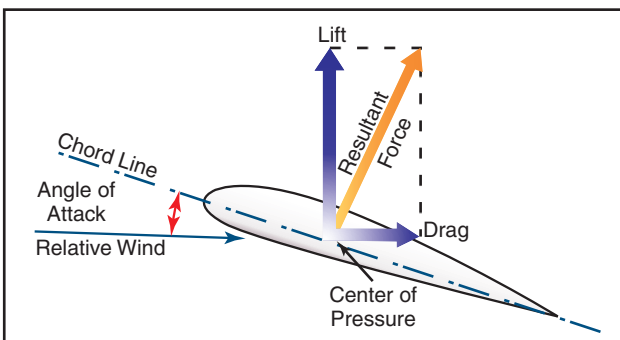

Figure 2-9. Force vectors on an airfoil.

angle of attack, the center of pressure is the point where the resultant force crosses the chord line. This point is expressed as a percentage of the chord of the airfoil. A center of pressure at 30 percent of a 60-inch chord would be 18 inches aft of the wing's leading edge. It would appear then that if the designer would place the wing so that its center of pressure was at the airplane's center of gravity, the airplane would always balance. The difficulty arises, however, that the location of the center of pressure changes with change in the airfoil's angle of attack. [Figure 2-10]

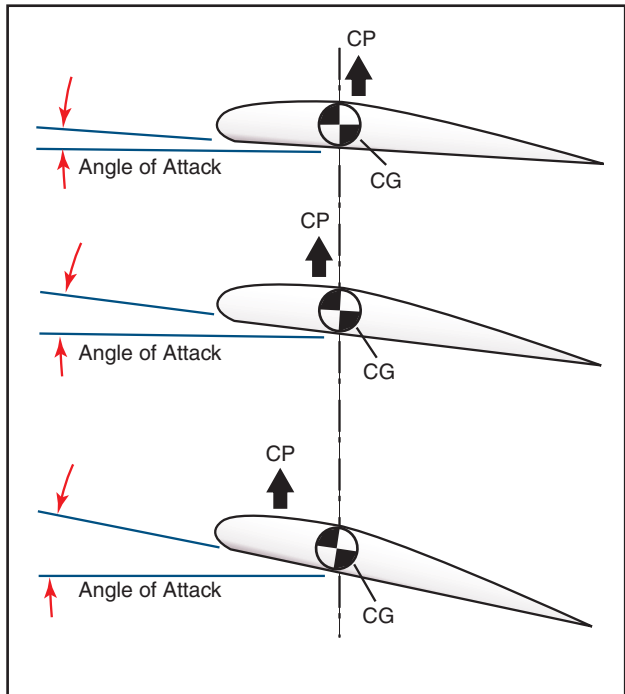
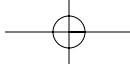

Figure 2-10. CP changes with an angle of attack.

In the airplane's normal range of flight attitudes, if the angle of attack is increased, the center of pressure moves forward; and if decreased, it moves rearward. Since the center of gravity is fixed at one point, it is evident that as the angle of attack increases, the center of lift (CL) moves ahead of the center of gravity, creating a force which tends to raise the nose of the airplane or tends to increase the angle of attack still more. On the other hand, if the angle of attack is decreased, the center of lift (CL) moves aft and tends to decrease the angle a greater amount. It is seen then, that the ordinary airfoil is inherently unstable, and that an auxiliary device, such as the horizontal tail surface, must be added to make the airplane balance longitudinally.

The balance of an airplane in flight depends, therefore, on the relative position of the center of gravity (CG) and the center of pressure (CP) of the airfoil. Experience has shown that an airplane with the center



of gravity in the vicinity of 20 percent of the wing chord can be made to balance and fly satisfactorily.

The tapered wing presents a variety of wing chords throughout the span of the wing. It becomes necessary then, to specify some chord about which the point of balance can be expressed. This chord, known as the mean aerodynamic chord (MAC),

usually is defined as the chord of an imaginary untapered wing, which would have the same center of pressure characteristics as the wing in question.

Airplane loading and weight distribution also affect center of gravity and cause additional forces, which in turn affect airplane balance.

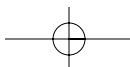



## Chapter 3

# Aerodynamics of Flight

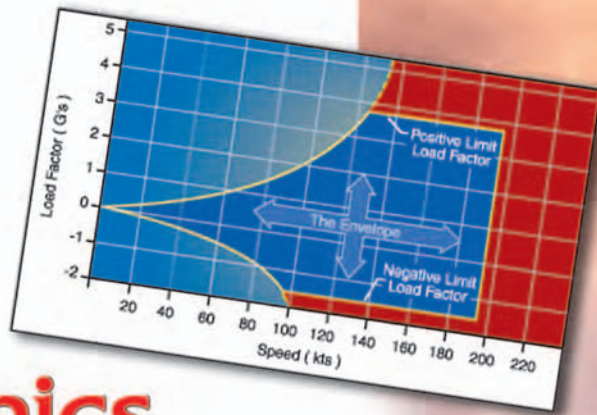

### FORCES ACTING ON THE AIRPLANE

In some respects at least, how well a pilot performs in flight depends upon the ability to plan and coordinate the use of the power and flight controls for changing the forces of thrust, drag, lift, and weight. It is the balance between these forces that the pilot must always control. The better the understanding of the forces and means of controlling them, the greater will be the pilot's skill at doing so.

The following defines these forces in relation to straight-and-level, unaccelerated flight.

**Thrust** is the forward force produced by the powerplant/propeller. It opposes or overcomes the force of drag. As a general rule, it is said to act parallel to the longitudinal axis. However, this is not always the case as will be explained later.

**Drag** is a rearward, retarding force, and is caused by disruption of airflow by the wing, fuselage, and other protruding objects. Drag opposes thrust, and acts rearward parallel to the relative wind.

**Weight** is the combined load of the airplane itself, the crew, the fuel, and the cargo or baggage. Weight pulls the airplane downward because of the force of gravity. It opposes lift, and acts vertically downward through the airplane's center of gravity.

**Lift** opposes the downward force of weight, is produced by the dynamic effect of the air acting on the wing, and acts perpendicular to the flightpath through the wing's center of lift.

In steady flight, the sum of these opposing forces is equal to zero. There can be no unbalanced forces in steady, straight flight (Newton's Third Law). This is true whether flying level or when climbing or descending. This is not the same thing as saying that the four forces are all equal. It simply means that the opposing forces are equal to, and thereby cancel the effects of, each other. Often the relationship between the four forces has been erroneously explained or illustrated in such a way that this point is obscured. Consider figure 3-1 on the next page, for example. In the upper illustration the force vectors of thrust, drag, lift, and weight appear to be equal in value. The usual explanation states (without stipulating that thrust and drag do not equal weight and lift) that thrust equals drag and lift equals weight as shown in the lower illustration. This basically true statement must be understood or it can be misleading. It should be understood that in straight, level, unaccelerated flight, it is true that the opposing lift/weight forces are equal, but they are also greater than the opposing forces of thrust/drag that are equal only to each other; not to lift/weight. To be correct about it, it must be said that in steady flight:

- The sum of all upward forces (not just lift) equals the sum of all downward forces (not just weight).
- The sum of all forward forces (not just thrust) equals the sum of all backward forces (not just drag).

This refinement of the old "thrust equals drag; lift equals weight" formula takes into account the fact that



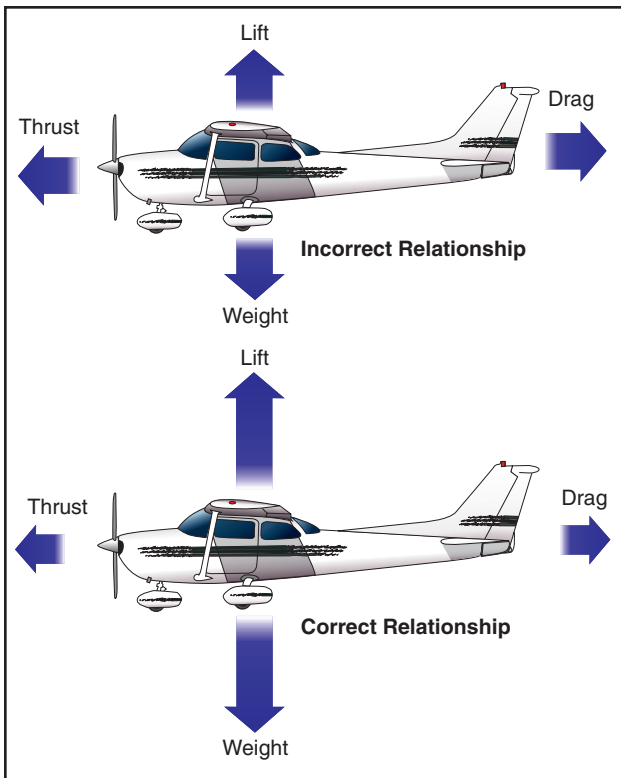
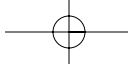

**Figure 3-1. Relationship of forces acting on an airplane.**

in climbs a portion of thrust, since it is directed upward, acts as if it were lift; and a portion of weight, since it is directed backward, acts as if it were drag. In glides, a portion of the weight vector is directed forward, and therefore acts as thrust. In other words, any time the flightpath of the airplane is not horizontal, lift, weight, thrust, and drag vectors must each be broken down into two components. [Figure 3-2]

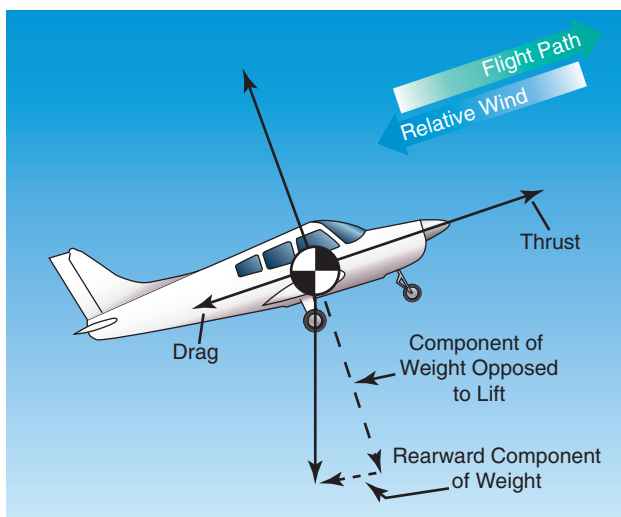

**Figure 3-2. Force vectors during a stabilized climb.**

Discussions of the preceding concepts are frequently omitted in aeronautical texts/handbooks/manuals. The reason is not that they are of no consequence, but because by omitting such discussions, the main ideas with respect to the aerodynamic forces acting upon

an airplane in flight can be presented in their most essential elements without being involved in the technicalities of the aerodynamicist. In point of fact, considering only level flight, and normal climbs and glides in a steady state, it is still true that wing lift is the really important upward force, and weight is the really important downward force.

Frequently, much of the difficulty encountered in explaining the forces that act upon an airplane is largely a matter of language and its meaning. For example, pilots have long believed that an airplane climbs because of excess lift. This is not true if one is thinking in terms of wing lift alone. It is true, however, if by lift it is meant the sum total of all “upward forces.” But when referring to the “lift of thrust” or the “thrust of weight,” the definitions previously established for these forces are no longer valid and complicate matters. It is this impreciseness in language that affords the excuse to engage in arguments, largely academic, over refinements to basic principles.

Though the forces acting on an airplane have already been defined, a discussion in more detail to establish how the pilot uses them to produce controlled flight is appropriate.

**THRUST**

Before the airplane begins to move, thrust must be exerted. It continues to move and gain speed until thrust and drag are equal. In order to maintain a constant airspeed, thrust and drag must remain equal, just as lift and weight must be equal to maintain a constant altitude. If in level flight, the engine power is reduced, the thrust is lessened, and the airplane slows down. As long as the thrust is less than the drag, the airplane continues to decelerate until its airspeed is insufficient to support it in the air.

Likewise, if the engine power is increased, thrust becomes greater than drag and the airspeed increases. As long as the thrust continues to be greater than the drag, the airplane continues to accelerate. When drag equals thrust, the airplane flies at a constant airspeed.

Straight-and-level flight may be sustained at speeds from very slow to very fast. The pilot must coordinate angle of attack and thrust in all speed regimes if the airplane is to be held in level flight. Roughly, these regimes can be grouped in three categories: low-speed flight, cruising flight, and high-speed flight.

When the airspeed is low, the angle of attack must be relatively high to increase lift if the balance between lift and weight is to be maintained. [Figure 3-3] If thrust decreases and airspeed decreases, lift becomes

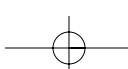

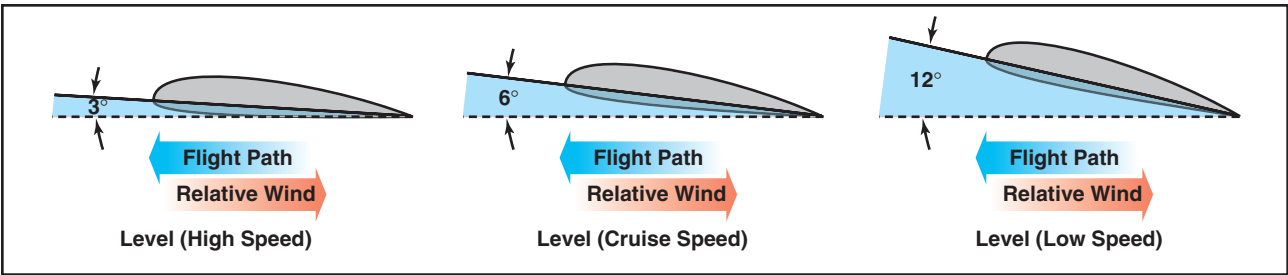

Figure 3-3. Angle of attack at various speeds.

less than weight and the airplane will start to descend. To maintain level flight, the pilot can increase the angle of attack an amount which will generate a lift force again equal to the weight of the airplane and while the airplane will be flying more slowly, it will still maintain level flight if the pilot has properly coordinated thrust and angle of attack.

Straight-and-level flight in the slow speed regime provides some interesting conditions relative to the equilibrium of forces, because with the airplane in a nose-high attitude, there is a vertical component of thrust that helps support the airplane. For one thing, wing loading tends to be less than would be expected. Most pilots are aware that an airplane will stall, other conditions being equal, at a slower speed with the power on than with the power off. (Induced airflow over the wings from the propeller also contributes to this.) However, if analysis is restricted to the four forces as they are usually defined, one can say that in straight-and-level slow speed flight the thrust is equal to drag, and lift is equal to weight.

During straight-and level-flight when thrust is increased and the airspeed increases, the angle of attack must be decreased. That is, if changes have been coordinated, the airplane will still remain in level flight but at a higher speed when the proper relationship between thrust and angle of attack is established.

If the angle of attack were not coordinated (decreased) with this increase of thrust, the airplane would climb. But decreasing the angle of attack modifies the lift, keeping it equal to the weight, and if properly done, the airplane still remains in level flight. Level flight at even slightly negative angles of attack is possible at very high speed. It is evident then, that level flight can be performed with any angle of attack between stalling angle and the relatively small negative angles found at high speed.

### DRAG

Drag in flight is of two basic types: parasite drag and induced drag. The first is called parasite because it in no way functions to aid flight, while the second is induced or created as a result of the wing developing lift.

Parasite drag is composed of two basic elements: form drag, resulting from the disruption of the streamline flow; and the resistance of skin friction.

Of the two components of parasite drag, form drag is the easier to reduce when designing an airplane. In general, a more streamlined object produces the best form to reduce parasite drag.

Skin friction is the type of parasite drag that is most difficult to reduce. No surface is perfectly smooth. Even machined surfaces, when inspected through magnification, have a ragged, uneven appearance. This rough surface will deflect the streamlines of air on the surface, causing resistance to smooth airflow. Skin friction can be minimized by employing a glossy, flat finish to surfaces, and by eliminating protruding rivet heads, roughness, and other irregularities.

Another element must be added to the consideration of parasite drag when designing an airplane. This drag combines the effects of form drag and skin friction and is called interference drag. If two objects are placed adjacent to one another, the resulting turbulence produced may be 50 to 200 percent greater than the parts tested separately.

The three elements, form drag, skin friction, and interference drag, are all computed to determine parasite drag on an airplane.

Shape of an object is a big factor in parasite drag. However, indicated airspeed is an equally important factor when speaking of parasite drag. The profile drag of a streamlined object held in a fixed position relative to the airflow increases approximately as the square of the velocity; thus, doubling the airspeed increases the drag four times, and tripling the airspeed increases the drag nine times. This relationship, however, holds good only at comparatively low subsonic speeds. At some higher airspeeds, the rate at which profile drag has been increased with speed suddenly begins to increase more rapidly.

The second basic type of drag is induced drag. It is an established physical fact that no system, which does work in the mechanical sense, can be 100 percent efficient. This means that whatever the nature

of the system, the required work is obtained at the expense of certain additional work that is dissipated or lost in the system. The more efficient the system, the smaller this loss.

In level flight the aerodynamic properties of the wing produce a required lift, but this can be obtained only at the expense of a certain penalty. The name given to this penalty is induced drag. Induced drag is inherent whenever a wing is producing lift and, in fact, this type of drag is inseparable from the production of lift. Consequently, it is always present if lift is produced.

The wing produces the lift force by making use of the energy of the free airstream. Whenever the wing is producing lift, the pressure on the lower surface of the wing is greater than that on the upper surface. As a result, the air tends to flow from the high pressure area below the wingtip upward to the low pressure area above the wing. In the vicinity of the wingtips, there is a tendency for these pressures to equalize, resulting in a lateral flow outward from the underside to the upper surface of the wing. This lateral flow imparts a rotational velocity to the air at the wingtips and trails behind the wing. Therefore, flow about the wingtips will be in the form of two vortices trailing behind as the wings move on.

When the airplane is viewed from the tail, these vortices will circulate counterclockwise about the right wingtip and clockwise about the left wingtip. [Figure 3-4] Bearing in mind the direction of rotation of these vortices, it can be seen that they induce an upward flow of air beyond the wingtip, and a downwash flow behind the wing's trailing edge. This induced downwash has nothing in common with the downwash that is necessary to produce lift. It is, in fact, the source of induced drag. The greater the size and strength of the vortices and consequent downwash component on the net airflow over the wing, the greater the induced drag effect becomes. This downwash over the top of the wing at the tip has the same effect as bending the lift vector rearward; therefore, the lift is slightly aft of perpendicular to the relative wind, creating a rearward lift component. This is induced drag.

It should be remembered that in order to create a greater negative pressure on the top of the wing, the wing can be inclined to a higher angle of attack; also, that if the angle of attack of an asymmetrical wing were zero, there would be no pressure differential and consequently no downwash component; therefore, no induced drag. In any case, as angle of attack increases, induced drag increases proportionally.

To state this another way—the lower the airspeed the greater the angle of attack required to produce lift

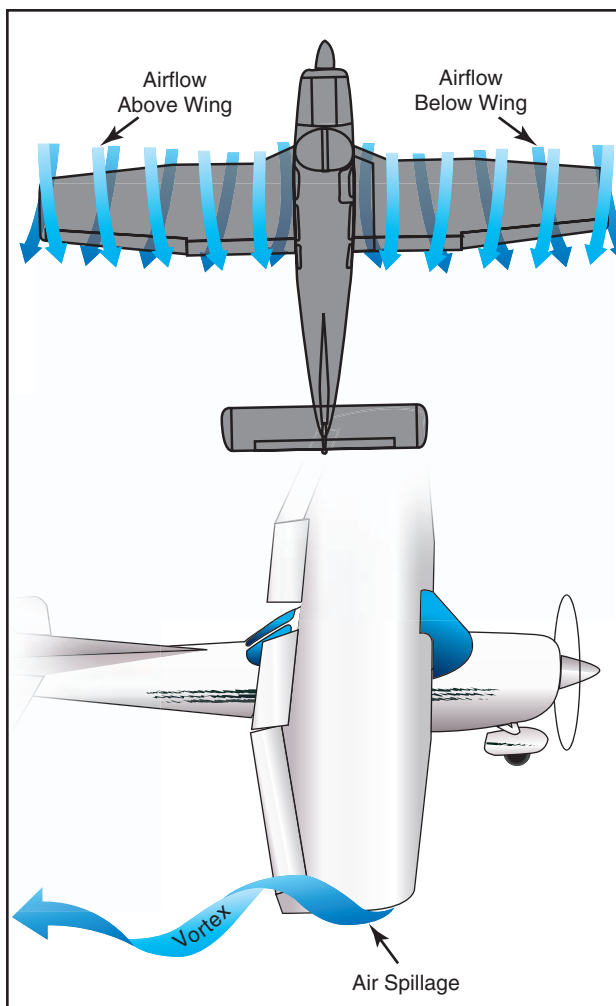

Figure 3-4. Wingtip vortices.

equal to the airplane's weight and consequently, the greater will be the induced drag. The amount of induced drag varies inversely as the square of the airspeed.

From the foregoing discussion, it can be noted that parasite drag increases as the square of the airspeed, and induced drag varies inversely as the square of the airspeed. It can be seen that as airspeed decreases to near the stalling speed, the total drag becomes greater, due mainly to the sharp rise in induced drag. Similarly, as the airspeed reaches the terminal velocity of the airplane, the total drag again increases rapidly, due to the sharp increase of parasite drag. As seen in figure 3-5, at some given airspeed, total drag is at its maximum amount. This is very important in figuring the maximum endurance and range of airplanes; for when drag is at a minimum, power required to overcome drag is also at a minimum.

To understand the effect of lift and drag on an airplane in flight, both must be combined and the lift/drag ratio considered. With the lift and drag data

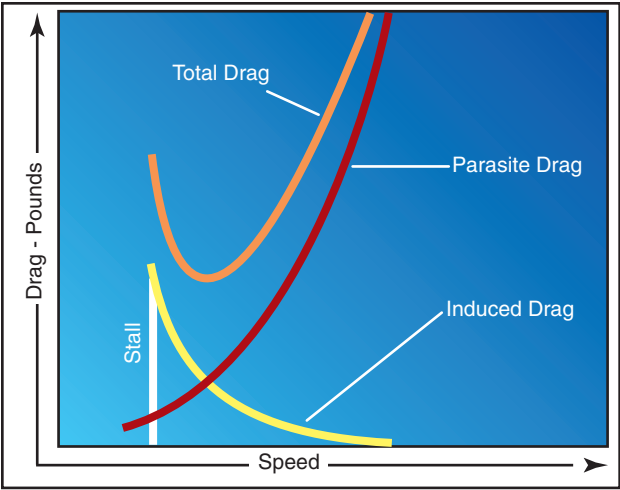

Figure 3-5. Drag versus speed.

available for various airspeeds of the airplane in steady, unaccelerated flight, the proportions of  $C_L$  (Coefficient of Lift) and  $C_D$  (Coefficient of Drag) can be calculated for each specific angle of attack. The resulting plot for lift/drag ratio with angle of attack shows that  $L/D$  increases to some maximum, then decreases at the higher lift coefficients and angles of attack, as shown in figure 3-6. Note that the maximum lift/drag ratio, ( $L/D$  max) occurs at one specific angle of attack and lift coefficient. If the airplane is operated in steady flight at  $L/D$  max, the total drag is at a minimum. Any angle of attack lower or higher than that for  $L/D$  max reduces the lift/drag ratio and consequently increases the total drag for a given airplane's lift.

The location of the center of gravity (CG) is determined by the general design of each particular airplane. The

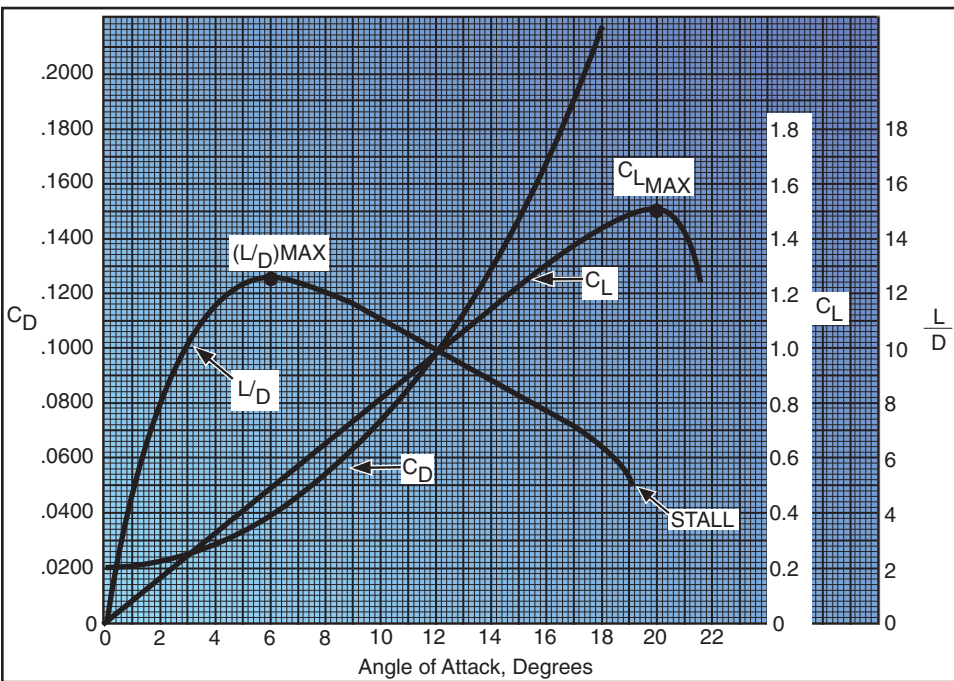

Figure 3-6. Lift coefficients at various angles of attack.

designers determine how far the center of pressure (CP) will travel. They then fix the center of gravity forward of the center of pressure for the corresponding flight speed in order to provide an adequate restoring moment to retain flight equilibrium.

The configuration of an airplane has a great effect on the lift/drag ratio. The high performance sailplane may have extremely high lift/drag ratios. The supersonic fighter may have seemingly low lift/drag ratios in subsonic flight, but the airplane configurations required for supersonic flight (and high  $L/D$ s at high Mach numbers) cause this situation.

**WEIGHT**

Gravity is the pulling force that tends to draw all bodies to the center of the earth. The center of gravity (CG) may be considered as a point at which all the weight of the airplane is concentrated. If the airplane were supported at its exact center of gravity, it would balance in any attitude. It will be noted that center of gravity is of major importance in an airplane, for its position has a great bearing upon stability.

The location of the center of gravity is determined by the general design of each particular airplane. The designers determine how far the center of pressure (CP) will travel. They then fix the center of gravity forward of the center of pressure for the corresponding flight speed in order to provide an adequate restoring moment to retain flight equilibrium.

Weight has a definite relationship with lift, and thrust with drag. This relationship is simple, but important in understanding the aerodynamics of flying. Lift

is the upward force on the wing acting perpendicular to the relative wind. Lift is required to counteract the airplane's weight (which is caused by the force of gravity acting on the mass of the airplane). This weight (gravity) force acts downward through the airplane's center of gravity. In stabilized level flight, when the lift force is equal to the weight force, the airplane is in a state of equilibrium and neither gains nor loses altitude. If lift becomes less than weight, the airplane loses



altitude. When the lift is greater than weight, the airplane gains altitude.

### LIFT

The pilot can control the lift. Any time the control wheel is more fore or aft, the angle of attack is changed. As angle of attack increases, lift increases (all other factors being equal). When the airplane reaches the maximum angle of attack, lift begins to diminish rapidly. This is the stalling angle of attack, or burble point.

Before proceeding further with lift and how it can be controlled, velocity must be interjected. The shape of the wing cannot be effective unless it continually keeps “attacking” new air. If an airplane is to keep flying, it must keep moving. Lift is proportional to the square of the airplane’s velocity. For example, an airplane traveling at 200 knots has four times the lift as the same airplane traveling at 100 knots, if the angle of attack and other factors remain constant.

Actually, the airplane could not continue to travel in level flight at a constant altitude and maintain the same angle of attack if the velocity is increased. The lift would increase and the airplane would climb as a result of the increased lift force. Therefore, to maintain the lift and weight forces in balance, and to keep the airplane “straight and level” (not accelerating upward) in a state of equilibrium, as velocity is increased, lift must be decreased. This is normally accomplished by reducing the angle of attack; i.e., lowering the nose. Conversely, as the airplane is slowed, the decreasing velocity requires increasing the angle of attack to maintain lift sufficient to maintain flight. There is, of course, a limit to how far the angle of attack can be increased, if a stall is to be avoided.

Therefore, it may be concluded that for every angle of attack there is a corresponding indicated airspeed required to maintain altitude in steady, unaccelerated flight—all other factors being constant. (Bear in mind this is only true if maintaining “level flight.”) Since an airfoil will always stall at the same angle of attack, if increasing weight, lift must also be increased, and the only method for doing so is by increased velocity if the angle of attack is held constant just short of the “critical” or stalling angle of attack.

Lift and drag also vary directly with the density of the air. Density is affected by several factors: pressure, temperature, and humidity. Remember, at an altitude of 18,000 feet, the density of the air has one-half the density of air at sea level. Therefore, in order to maintain its lift at a higher altitude, an

airplane must fly at a greater true airspeed for any given angle of attack.

Furthermore, warm air is less dense than cool air, and moist air is less dense than dry air. Thus, on a hot humid day, an airplane must be flown at a greater true airspeed for any given angle of attack than on a cool, dry day.

If the density factor is decreased and the total lift must equal the total weight to remain in flight, it follows that one of the other factors must be increased. The factors usually increased are the airspeed or the angle of attack, because these factors can be controlled directly by the pilot.

It should also be pointed out that lift varies directly with the wing area, provided there is no change in the wing’s planform. If the wings have the same proportion and airfoil sections, a wing with a planform area of 200 square feet lifts twice as much at the same angle of attack as a wing with an area of 100 square feet.

As can be seen, two major factors from the pilot’s viewpoint are lift and velocity because these are the two that can be controlled most readily and accurately. Of course, the pilot can also control density by adjusting the altitude and can control wing area if the airplane happens to have flaps of the type that enlarge wing area. However, for most situations, the pilot is controlling lift and velocity to maneuver the airplane. For instance, in straight-and-level flight, cruising along at a constant altitude, altitude is maintained by adjusting lift to match the airplane’s velocity or cruise airspeed, while maintaining a state of equilibrium where lift equals weight. In an approach to landing, when the pilot wishes to land as slowly as practical, it is necessary to increase lift to near maximum to maintain lift equal to the weight of the airplane.

### WINGTIP VORTICES

The action of the airfoil that gives an airplane lift also causes induced drag. It was determined that when a wing is flown at a positive angle of attack, a pressure differential exists between the upper and lower surfaces of the wing—that is, the pressure above the wing is less than atmospheric pressure and the pressure below the wing is equal to or greater than atmospheric pressure. Since air always moves from high pressure toward low pressure, and the path of least resistance is toward the airplane’s wingtips, there is a spanwise movement of air from the bottom of the wing outward from the fuselage around the wingtips. This flow of air results in “spillage” over the wingtips, thereby setting up a whirlpool of air

called a “vortex.” [Figure 3-4] At the same time, the air on the upper surface of the wing has a tendency to flow in toward the fuselage and off the trailing edge. This air current forms a similar vortex at the inboard portion of the trailing edge of the wing, but because the fuselage limits the inward flow, the vortex is insignificant. Consequently, the deviation in flow direction is greatest at the wingtips where the unrestricted lateral flow is the strongest. As the air curls upward around the wingtip, it combines with the wing’s downwash to form a fast spinning trailing vortex. These vortices increase drag because of energy spent in producing the turbulence. It can be seen, then, that whenever the wing is producing lift, induced drag occurs, and wingtip vortices are created.

Just as lift increases with an increase in angle of attack, induced drag also increases. This occurs because as the angle of attack is increased, there is a greater pressure difference between the top and bottom of the wing, and a greater lateral flow of air; consequently, this causes more violent vortices to be set up, resulting in more turbulence and more induced drag.

The intensity or strength of the wingtip vortices is directly proportional to the weight of the airplane and inversely proportional to the wingspan and speed of the airplane. The heavier and slower the airplane, the greater the angle of attack and the stronger the wingtip vortices. Thus, an airplane will create wingtip vortices with maximum strength occurring during the takeoff, climb, and landing phases of flight.

## GROUND EFFECT

It is possible to fly an airplane just clear of the ground (or water) at a slightly slower airspeed than that required to sustain level flight at higher altitudes. This is the result of a phenomenon, which is better known than understood even by some experienced pilots.

When an airplane in flight gets within several feet from the ground surface, a change occurs in the three-dimensional flow pattern around the airplane because the vertical component of the airflow around the wing is restricted by the ground surface. This alters the wing’s upwash, downwash, and wingtip vortices. [Figure 3-7] These general effects due to the presence

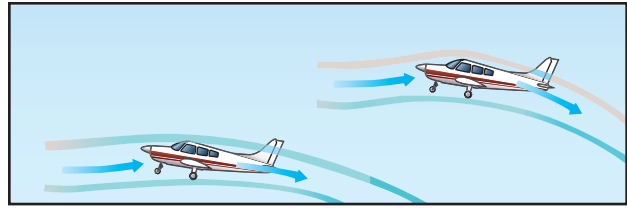

Figure 3-7. Ground effect changes airflow.

of the ground are referred to as “ground effect.” Ground effect, then, is due to the interference of the ground (or water) surface with the airflow patterns about the airplane in flight.

While the aerodynamic characteristics of the tail surfaces and the fuselage are altered by ground effects, the principal effects due to proximity of the ground are the changes in the aerodynamic characteristics of the wing. As the wing encounters ground effect and is maintained at a constant lift coefficient, there is consequent reduction in the upwash, downwash, and the wingtip vortices.

Induced drag is a result of the wing’s work of sustaining the airplane and the wing lifts the airplane simply by accelerating a mass of air downward. It is true that reduced pressure on top of an airfoil is essential to lift, but that is but one of the things that contributes to the overall effect of pushing an air mass downward. The more downwash there is, the harder the wing is pushing the mass of air down. At high angles of attack, the amount of induced drag is high and since this corresponds to lower airspeeds in actual flight, it can be said that induced drag predominates at low speed.

However, the reduction of the wingtip vortices due to ground effect alters the spanwise lift distribution and reduces the induced angle of attack and induced drag. Therefore, the wing will require a lower angle of attack in ground effect to produce the same lift coefficient or, if a constant angle of attack is maintained, an increase in lift coefficient will result. [Figure 3-8]

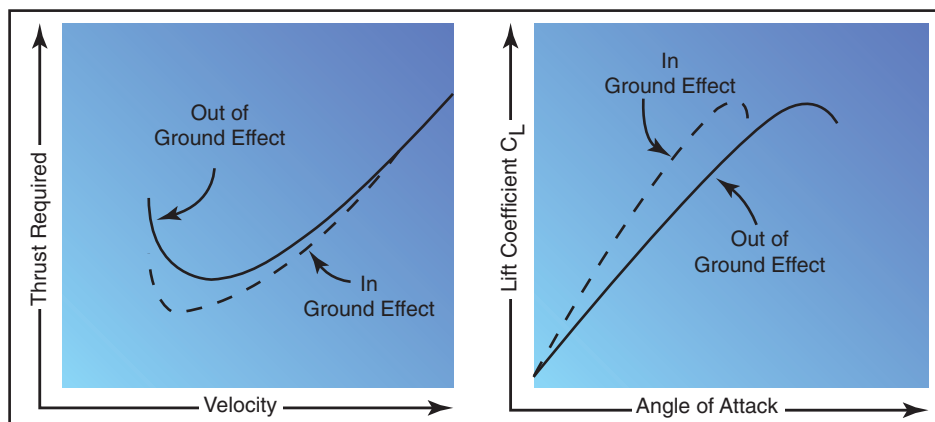
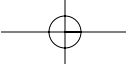

Figure 3-8. Ground effect changes drag and lift.





Ground effect also will alter the thrust required versus velocity. Since induced drag predominates at low speeds, the reduction of induced drag due to ground effect will cause the most significant reduction of thrust required (parasite plus induced drag) at low speeds.

The reduction in induced flow due to ground effect causes a significant reduction in induced drag but causes no direct effect on parasite drag. As a result of the reduction in induced drag, the thrust required at low speeds will be reduced.

Due to the change in upwash, downwash, and wingtip vortices, there may be a change in position (installation) error of the airspeed system, associated with ground effect. In the majority of cases, ground effect will cause an increase in the local pressure at the static source and produce a lower indication of airspeed and altitude. Thus, the airplane may be airborne at an indicated airspeed less than that normally required.

In order for ground effect to be of significant magnitude, the wing must be quite close to the ground. One of the direct results of ground effect is the variation of induced drag with wing height above the ground at a constant lift coefficient. When the wing is at a height equal to its span, the reduction in induced drag is only 1.4 percent. However, when the wing is at a height equal to one-fourth its span, the reduction in induced drag is 23.5 percent and, when the wing is at a height equal to one-tenth its span, the reduction in induced drag is 47.6 percent. Thus, a large reduction in induced drag will take place only when the wing is very close to the ground. Because of this variation, ground effect is most usually recognized during the liftoff for takeoff or just prior to touchdown when landing.

During the takeoff phase of flight, ground effect produces some important relationships. The airplane leaving ground effect after takeoff encounters just the reverse of the airplane entering ground effect during landing; i.e., the airplane leaving ground effect will:

- Require an increase in angle of attack to maintain the same lift coefficient.
- Experience an increase in induced drag and thrust required.
- Experience a decrease in stability and a nose-up change in moment.
- Produce a reduction in static source pressure and increase in indicated airspeed.

These general effects should point out the possible danger in attempting takeoff prior to achieving the recommended takeoff speed. Due to the reduced drag in ground effect, the airplane may seem capable of takeoff well below the recommended speed. However, as the airplane rises out of ground effect with a deficiency of speed, the greater induced drag may result in very marginal initial climb performance. In the extreme conditions such as high gross weight, high density altitude, and high temperature, a deficiency of airspeed during takeoff may permit the airplane to become airborne but be incapable of flying out of ground effect. In this case, the airplane may become airborne initially with a deficiency of speed, and then settle back to the runway. It is important that no attempt be made to force the airplane to become airborne with a deficiency of speed; the recommended takeoff speed is necessary to provide adequate initial climb performance. For this reason, it is imperative that a definite climb be established before retracting the landing gear or flaps.

During the landing phase of flight, the effect of proximity to the ground also must be understood and appreciated. If the airplane is brought into ground effect with a constant angle of attack, the airplane will experience an increase in lift coefficient and a reduction in the thrust required. Hence, a “floating” effect may occur. Because of the reduced drag and power off deceleration in ground effect, any excess speed at the point of flare may incur a considerable “float” distance. As the airplane nears the point of touchdown, ground effect will be most realized at altitudes less than the wingspan. During the final phases of the approach as the airplane nears the ground, a reduced power setting is necessary or the reduced thrust required would allow the airplane to climb above the desired glidepath.

## AXES OF AN AIRPLANE

Whenever an airplane changes its flight attitude or position in flight, it rotates about one or more of three axes, which are imaginary lines that pass through the airplane’s center of gravity. The axes of an airplane can be considered as imaginary axles around which the airplane turns, much like the axle around which a wheel rotates. At the point where all three axes intersect, each is at a 90° angle to the other two. The axis, which extends lengthwise through the fuselage from the nose to the tail, is the longitudinal axis. The axis, which extends crosswise from wingtip to wingtip, is the lateral axis. The axis, which passes vertically through the center of gravity, is the vertical axis. [Figure 3-9]

The airplane’s motion about its longitudinal axis resembles the roll of a ship from side to side. In fact,

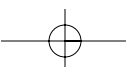

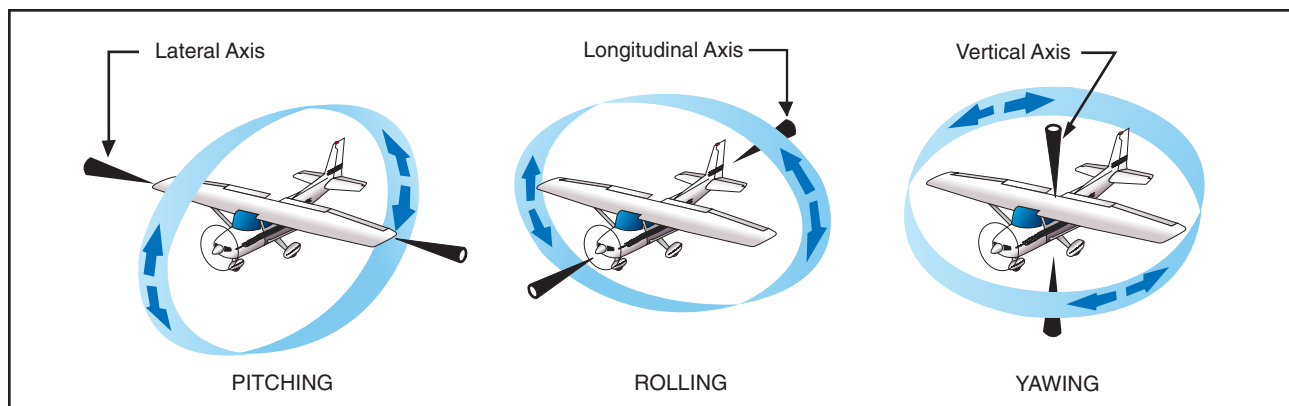
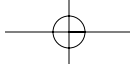

Figure 3-9. Axes of an airplane.

the names used in describing the motion about an airplane's three axes were originally nautical terms. They have been adapted to aeronautical terminology because of the similarity of motion between an airplane and the seagoing ship.

In light of the adoption of nautical terms, the motion about the airplane's longitudinal axis is called "roll"; motion about its lateral axis is referred to as "pitch." Finally, an airplane moves about its vertical axis in a motion, which is termed "yaw"—that is, a horizontal (left and right) movement of the airplane's nose.

The three motions of the airplane (roll, pitch, and yaw) are controlled by three control surfaces. Roll is controlled by the ailerons; pitch is controlled by the elevators; yaw is controlled by the rudder. The use of these controls is explained in Chapter 4—Flight Controls.

## MOMENTS AND MOMENT ARM

A study of physics shows that a body that is free to rotate will always turn about its center of gravity. In aerodynamic terms, the mathematical measure of an airplane's tendency to rotate about its center of gravity is called a "moment." A moment is said to be equal to the product of the force applied and the distance at which the force is applied. (A moment arm is the distance from a datum [reference point or line] to the applied force.) For airplane weight and balance computations, "moments" are expressed in terms of the distance of the arm times the airplane's weight, or simply, inch pounds.

Airplane designers locate the fore and aft position of the airplane's center of gravity as nearly as possible to the 20 percent point of the mean aerodynamic chord (MAC). If the thrust line is designed to pass horizontally through the center of gravity, it will not cause the airplane to pitch when power is changed, and there will be no difference in moment due to thrust for a power-on or power-off condition of flight. Although designers have some control over

the location of the drag forces, they are not always able to make the resultant drag forces pass through the center of gravity of the airplane. However, the one item over which they have the greatest control is the size and location of the tail. The objective is to make the moments (due to thrust, drag, and lift) as small as possible; and, by proper location of the tail, to provide the means of balancing the airplane longitudinally for any condition of flight.

The pilot has no direct control over the location of forces acting on the airplane in flight, except for controlling the center of lift by changing the angle of attack. Such a change, however, immediately involves changes in other forces. Therefore, the pilot cannot independently change the location of one force without changing the effect of others. For example, a change in airspeed involves a change in lift, as well as a change in drag and a change in the up or down force on the tail. As forces such as turbulence and gusts act to displace the airplane, the pilot reacts by providing opposing control forces to counteract this displacement.

Some airplanes are subject to changes in the location of the center of gravity with variations of load. Trimming devices are used to counteract the forces set up by fuel burnoff, and loading or off-loading of passengers or cargo. Elevator trim tabs and adjustable horizontal stabilizers comprise the most common devices provided to the pilot for trimming for load variations. Over the wide ranges of balance during flight in large airplanes, the force which the pilot has to exert on the controls would become excessive and fatiguing if means of trimming were not provided.

## DESIGN CHARACTERISTICS

Every pilot who has flown numerous types of airplanes has noted that each airplane handles somewhat differently—that is, each resists or responds to control pressures in its own way. A training type airplane is quick to respond to control applications,

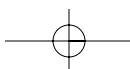

while a transport airplane usually feels heavy on the controls and responds to control pressures more slowly. These features can be designed into an airplane to facilitate the particular purpose the airplane is to fulfill by considering certain stability and maneuvering requirements. In the following discussion, it is intended to summarize the more important aspects of an airplane's stability; its maneuvering and controllability qualities; how they are analyzed; and their relationship to various flight conditions. In brief, the basic differences between stability, maneuverability, and controllability are as follows:

- **Stability**—The inherent quality of an airplane to correct for conditions that may disturb its equilibrium, and to return or to continue on the original flightpath. It is primarily an airplane design characteristic.
- **Maneuverability**—The quality of an airplane that permits it to be maneuvered easily and to withstand the stresses imposed by maneuvers. It is governed by the airplane's weight, inertia, size and location of flight controls, structural strength, and powerplant. It too is an airplane design characteristic.
- **Controllability**—The capability of an airplane to respond to the pilot's control, especially with regard to flightpath and attitude. It is the quality of the airplane's response to the pilot's control application when maneuvering the airplane, regardless of its stability characteristics.

structural strength. These limitations indicate the maximum performance and maneuverability of the airplane. If the airplane is to provide maximum utility, it must be safely controllable to the full extent of these limits without exceeding the pilot's strength or requiring exceptional flying ability. If an airplane is to fly straight and steady along any arbitrary flightpath, the forces acting on it must be in static equilibrium. The reaction of any body when its equilibrium is disturbed is referred to as stability. There are two types of stability; static and dynamic. Static will be discussed first, and in this discussion the following definitions will apply:

- **Equilibrium**—All opposing forces acting on the airplane are balanced; (i.e., steady, unaccelerated flight conditions).
- **Static Stability**—The initial tendency that the airplane displays after its equilibrium is disturbed.
- **Positive Static Stability**—The initial tendency of the airplane to return to the original state of equilibrium after being disturbed. [Figure 3-10]
- **Negative Static Stability**—The initial tendency of the airplane to continue away from the original state of equilibrium after being disturbed. [Figure 3-10]
- **Neutral Static Stability**—The initial tendency of the airplane to remain in a new condition after its equilibrium has been disturbed. [Figure 3-10]

### BASIC CONCEPTS OF STABILITY

The flightpaths and attitudes in which an airplane can fly are limited only by the aerodynamic characteristics of the airplane, its propulsive system, and its

### STATIC STABILITY

Stability of an airplane in flight is slightly more complex than just explained, because the airplane is free to move in any direction and must be controllable in

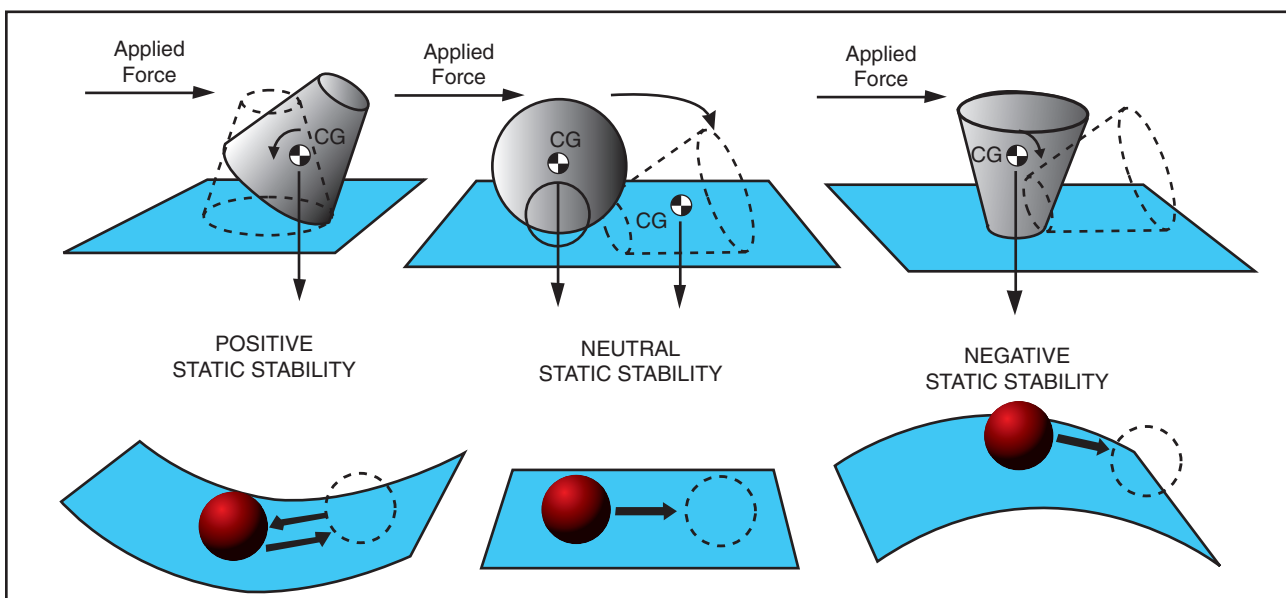

Figure 3-10. Types of stability.

pitch, roll, and direction. When designing the airplane, engineers must compromise between stability, maneuverability, and controllability; and the problem is compounded because of the airplane's three-axis freedom. Too much stability is detrimental to maneuverability, and similarly, not enough stability is detrimental to controllability. In the design of airplanes, compromise between the two is the keyword.

### DYNAMIC STABILITY

Static stability has been defined as the initial tendency that the airplane displays after being disturbed from its trimmed condition. Occasionally, the initial tendency is different or opposite from the overall tendency, so distinction must be made between the two. Dynamic stability is the overall tendency that the airplane displays after its equilibrium is disturbed. The curves of figure 3-11 represent the variation of controlled functions versus time. It is seen that the unit of time is very significant. If the time unit for one cycle or oscillation is above 10 seconds' duration, it is called a "long-period" oscillation (phugoid) and is easily controlled. In a longitudinal phugoid oscillation, the angle of attack remains constant when the airspeed increases and decreases. To a certain degree, a convergent phugoid is desirable but is not required. The phugoid can be determined only on a statically stable airplane, and this has a great effect on the trimming qualities of the airplane. If the time unit for one cycle or oscillation is less than one or two seconds, it is called a "short-period" oscillation and is normally very difficult, if not impossible, for the pilot to control. This is the type of oscillation that the pilot can easily "get in phase with" and reinforce.

A neutral or divergent, short-period oscillation is dangerous because structural failure usually results if the oscillation is not damped immediately. Short-period oscillations affect airplane and control surfaces alike and reveal themselves as "porpoising" in the airplane, or as in "buzz" or "flutter" in the control surfaces. Basically, the short-period oscillation is a change in angle of attack with no change in airspeed. A short-period oscillation of a control surface is usually of such high frequency that the airplane does not have time to react. Logically, the Code of Federal Regulations require that short-period oscillations be heavily damped (i.e., die out immediately). Flight tests during the airworthiness certification of airplanes are conducted for this condition by inducing the oscillation in the controls for pitch, roll, or yaw at the most critical speed (i.e., at  $V_{NE}$ , the never-exceed speed). The test pilot strikes the control wheel or rudder pedal a sharp blow and observes the results.

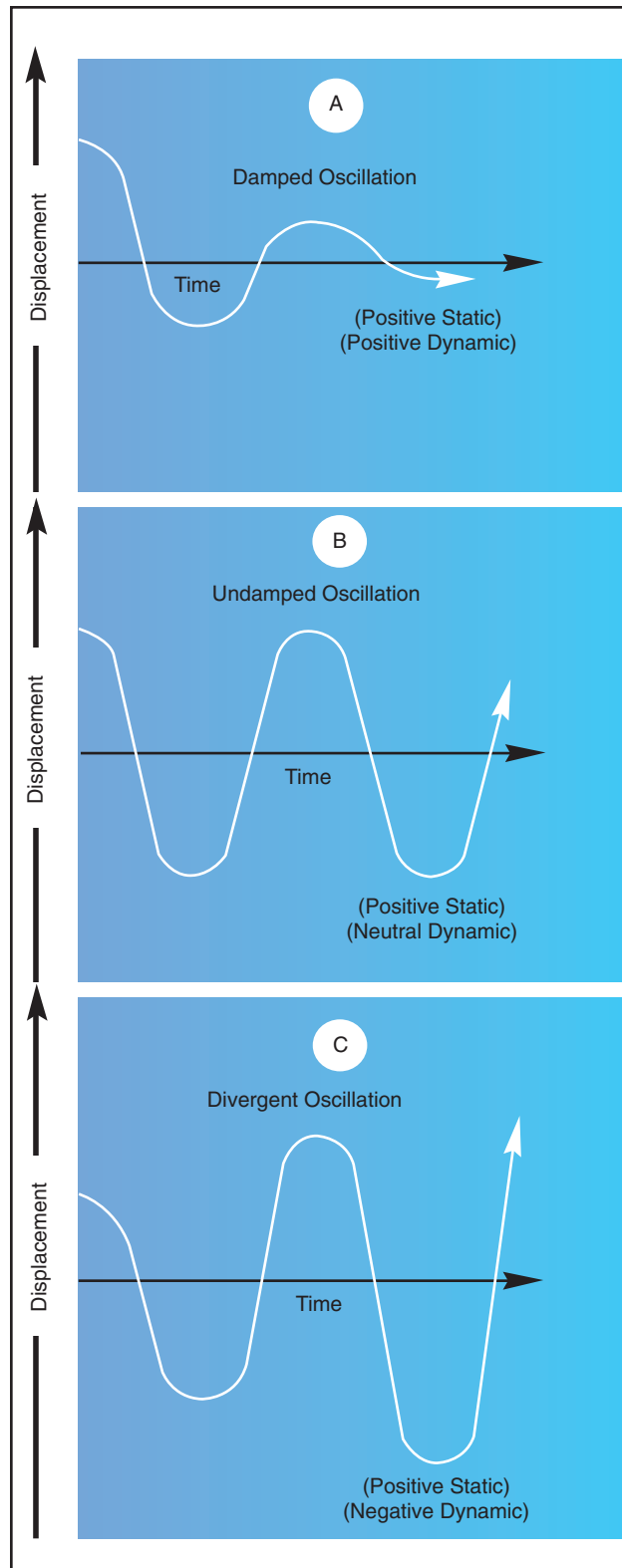

Figure 3-11. Damped versus undamped stability.

### LONGITUDINAL STABILITY (PITCHING)

In designing an airplane, a great deal of effort is spent in developing the desired degree of stability around all three axes. But longitudinal stability about the lateral axis is considered to be the most affected by certain variables in various flight conditions.



Longitudinal stability is the quality that makes an airplane stable about its lateral axis. It involves the pitching motion as the airplane's nose moves up and down in flight. A longitudinally unstable airplane has a tendency to dive or climb progressively into a very steep dive or climb, or even a stall. Thus, an airplane with longitudinal instability becomes difficult and sometimes dangerous to fly.

Static longitudinal stability or instability in an airplane, is dependent upon three factors:

1. Location of the wing with respect to the center of gravity;
2. Location of the horizontal tail surfaces with respect to the center of gravity; and
3. The area or size of the tail surfaces.

In analyzing stability, it should be recalled that a body that is free to rotate will always turn about its center of gravity.

To obtain static longitudinal stability, the relation of the wing and tail moments must be such that, if the moments are initially balanced and the airplane is suddenly nosed up, the wing moments and tail moments will change so that the sum of their forces will provide an unbalanced but restoring moment which, in turn, will bring the nose down again. Similarly, if the airplane is nosed down, the resulting change in moments will bring the nose back up.

The center of lift, sometimes called the center of pressure, in most unsymmetrical airfoils has a tendency to change its fore and aft position with a change in the angle of attack. The center of pressure tends to move forward with an increase in angle of attack and to move aft with a decrease in angle of attack. This means that when the angle of attack of an airfoil is increased, the center of pressure (lift) by moving forward, tends to lift the leading edge of the wing still more. This tendency gives the wing an inherent quality of instability.

Figure 3-12 shows an airplane in straight-and-level flight. The line CG-CL-T represents the airplane's longitudinal axis from the center of gravity (CG) to a point T on the horizontal stabilizer. The center of lift (or center of pressure) is represented by the point CL.

Most airplanes are designed so that the wing's center of lift (CL) is to the rear of the center of gravity. This makes the airplane "nose heavy" and requires that there be a slight downward force on the horizontal stabilizer in order to balance the airplane and keep

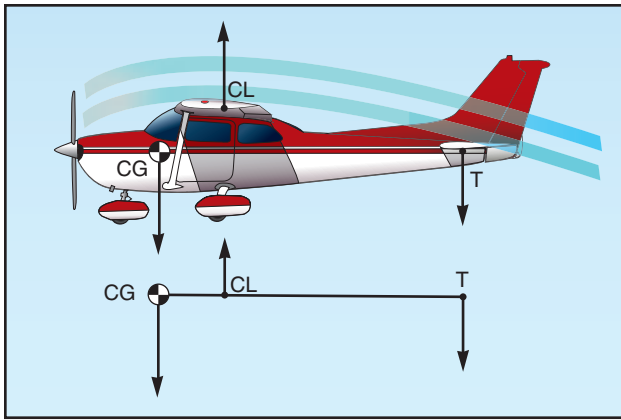

Figure 3-12. Longitudinal stability.

the nose from continually pitching downward. Compensation for this nose heaviness is provided by setting the horizontal stabilizer at a slight negative angle of attack. The downward force thus produced, holds the tail down, counterbalancing the "heavy" nose. It is as if the line CG-CL-T was a lever with an upward force at CL and two downward forces balancing each other, one a strong force at the CG point and the other, a much lesser force, at point T (downward air pressure on the stabilizer). Applying simple physics principles, it can be seen that if an iron bar were suspended at point CL with a heavy weight hanging on it at the CG, it would take some downward pressure at point T to keep the "lever" in balance.

Even though the horizontal stabilizer may be level when the airplane is in level flight, there is a downwash of air from the wings. This downwash strikes the top of the stabilizer and produces a downward pressure, which at a certain speed will be just enough to balance the "lever." The faster the airplane is flying, the greater this downwash and the greater the downward force on the horizontal stabilizer (except "T" tails). [Figure 3-13] In airplanes with fixed position horizontal stabilizers, the airplane manufacturer sets the stabilizer at an angle that will provide the best stability (or balance) during flight at the design cruising speed and power setting. [Figure 3-14]

If the airplane's speed decreases, the speed of the air-flow over the wing is decreased. As a result of this decreased flow of air over the wing, the downwash is reduced, causing a lesser downward force on the horizontal stabilizer. In turn, the characteristic nose heaviness is accentuated, causing the airplane's nose to pitch down more. This places the airplane in a nose-low attitude, lessening the wing's angle of attack and drag and allowing the airspeed to increase. As the airplane continues in the nose-low attitude and its speed increases, the downward force on the horizontal stabilizer is once again increased.



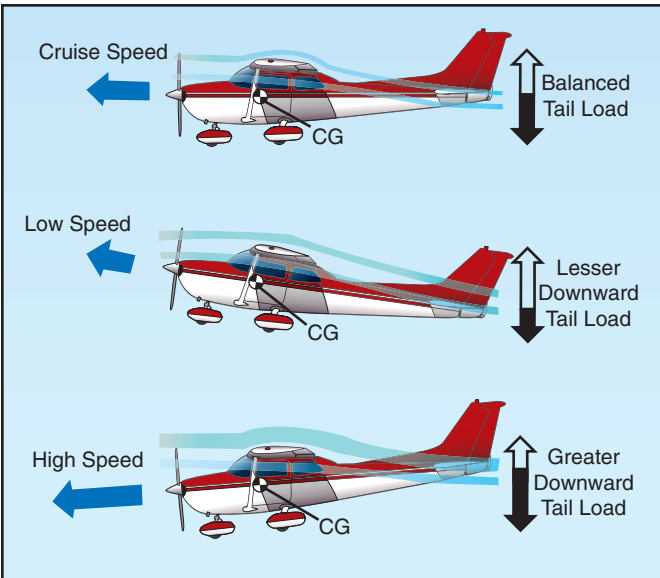

Figure 3-13. Effect of speed on downwash.

Consequently, the tail is again pushed downward and the nose rises into a climbing attitude.

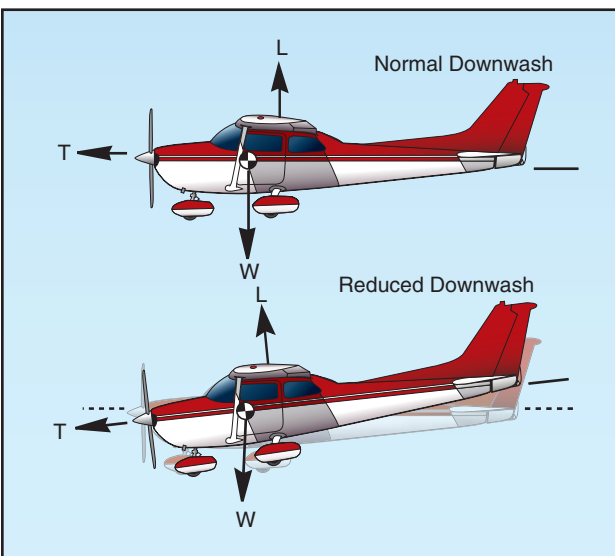

Figure 3-14. Reduced power allows pitch down.

As this climb continues, the airspeed again decreases, causing the downward force on the tail to decrease until the nose lowers once more. However, because the airplane is dynamically stable, the nose does not lower as far this time as it did before. The airplane will acquire enough speed in this more gradual dive to start it into another climb, but the climb is not so steep as the preceding one.

After several of these diminishing oscillations, in which the nose alternately rises and lowers, the airplane will finally settle down to a speed at which the downward force on the tail exactly counteracts the tendency of the airplane to dive. When this condition is attained, the airplane will once again

be in balanced flight and will continue in stabilized flight as long as this attitude and airspeed are not changed.

A similar effect will be noted upon closing the throttle. The downwash of the wings is reduced and the force at T in figure 3-12 is not enough to hold the horizontal stabilizer down. It is as if the force at T on the lever were allowing the force of gravity to pull the nose down. This, of course, is a desirable characteristic because the airplane is inherently trying to regain airspeed and reestablish the proper balance.

Power or thrust can also have a destabilizing effect in that an increase of power may tend to make the nose rise. The airplane designer can offset this by establishing a "high thrustline" wherein the line of thrust passes above the center of gravity. [Figures 3-15 and 3-16] In this case, as power or thrust is increased a moment is produced to counteract the down load on the tail. On the other hand, a very "low thrust line" would tend to add to the nose-up effect of the horizontal tail surface.

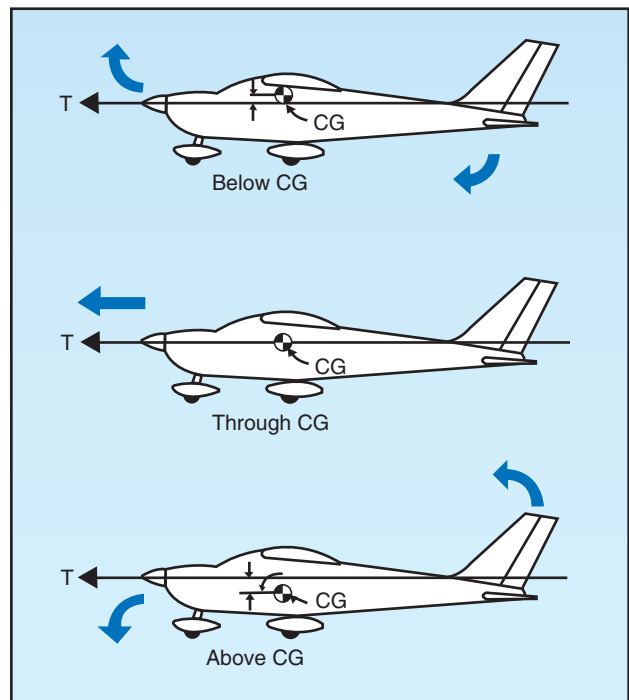

Figure 3-15. Thrust line affects longitudinal stability.

It can be concluded, then, that with the center of gravity forward of the center of lift, and with an aerodynamic tail-down force, the result is that the airplane always tries to return to a safe flying attitude.

A simple demonstration of longitudinal stability may be made as follows: Trim the airplane for "hands off" control in level flight. Then momentarily give the controls a slight push to nose the airplane down. If,

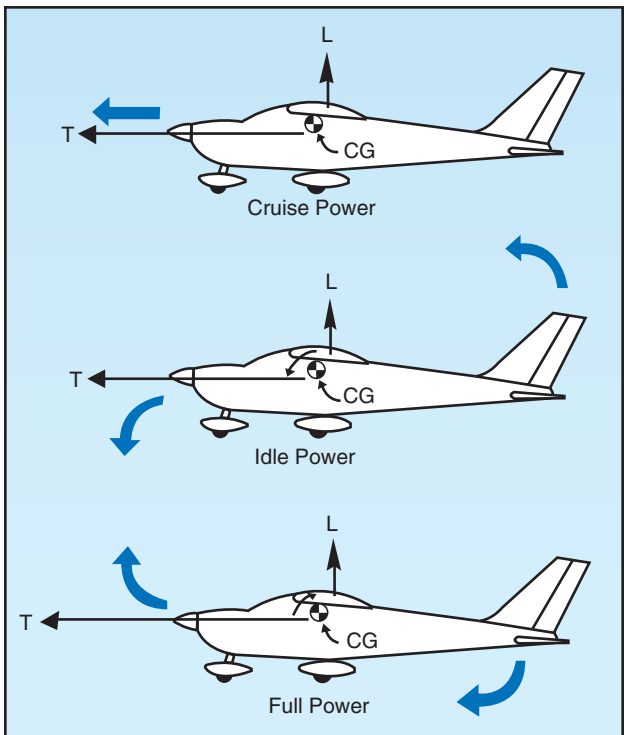

Figure 3-16. Power changes affect longitudinal stability.

within a brief period, the nose rises to the original position and then stops, the airplane is statically stable. Ordinarily, the nose will pass the original position (that of level flight) and a series of slow pitching oscillations will follow. If the oscillations gradually cease, the airplane has positive stability; if they continue unevenly, the airplane has neutral stability; if they increase, the airplane is unstable.

### LATERAL STABILITY (ROLLING)

Stability about the airplane's longitudinal axis, which extends from nose to tail, is called lateral stability. This helps to stabilize the lateral or rolling effect when one wing gets lower than the wing on the opposite side of the airplane. There are four main design factors that make an airplane stable laterally: dihedral, keel effect, sweepback, and weight distribution.

The most common procedure for producing lateral stability is to build the wings with a dihedral angle varying from one to three degrees. In other words, the wings on either side of the airplane join the fuselage to form a slight V or angle called "dihedral," and this is measured by the angle made by each wing above a line parallel to the lateral axis.

The basis of rolling stability is, of course, the lateral balance of forces produced by the airplane's wings. Any imbalance in lift results in a tendency for the airplane to roll about its longitudinal axis. Stated another way, dihedral involves a balance of

lift created by the wings' angle of attack on each side of the airplane's longitudinal axis.

If a momentary gust of wind forces one wing of the airplane to rise and the other to lower, the airplane will bank. When the airplane is banked without turning, it tends to sideslip or slide downward toward the lowered wing. [Figure 3-17] Since the wings have dihedral, the air strikes the low wing at much greater angle of attack than the high wing. This increases the lift on the low wing and decreases lift on the high wing, and tends to restore the airplane to its original lateral attitude (wings level)—that is, the angle of attack and lift on the two wings are again equal.

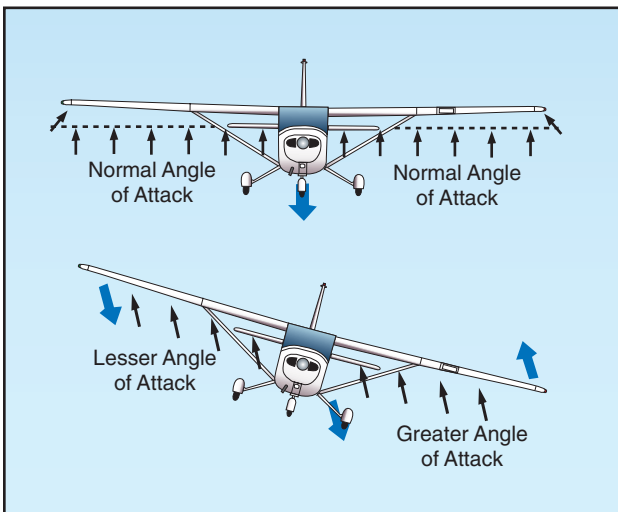

Figure 3-17. Dihedral for lateral stability.

The effect of dihedral, then, is to produce a rolling moment tending to return the airplane to a laterally balanced flight condition when a sideslip occurs.

The restoring force may move the low wing up too far, so that the opposite wing now goes down. If so, the process will be repeated, decreasing with each lateral oscillation until a balance for wings-level flight is finally reached.

Conversely, excessive dihedral has an adverse effect on lateral maneuvering qualities. The airplane may be so stable laterally that it resists any intentional rolling motion. For this reason, airplanes that require fast roll or banking characteristics usually have less dihedral than those designed for less maneuverability.

The contribution of sweepback to dihedral effect is important because of the nature of the contribution. In a sideslip, the wing into the wind is operating with an effective decrease in sweepback, while the wing out of the wind is operating with an effective increase in sweepback. The swept wing is responsive only to the wind component that is perpendicular to the wing's leading edge. Consequently, if the wing is

operating at a positive lift coefficient, the wing into the wind has an increase in lift, and the wing out of the wind has a decrease in lift. In this manner, the swept back wing would contribute a positive dihedral effect and the swept forward wing would contribute a negative dihedral effect.

During flight, the side area of the airplane's fuselage and vertical fin react to the airflow in much the same manner as the keel of a ship. That is, it exerts a steadying influence on the airplane laterally about the longitudinal axis.

Such laterally stable airplanes are constructed so that the greater portion of the keel area is above and behind the center of gravity. [Figure 3-18] Thus, when the airplane slips to one side, the combination of the airplane's weight and the pressure of the airflow against the upper portion of the keel area (both acting about the CG) tends to roll the airplane back to wings-level flight.

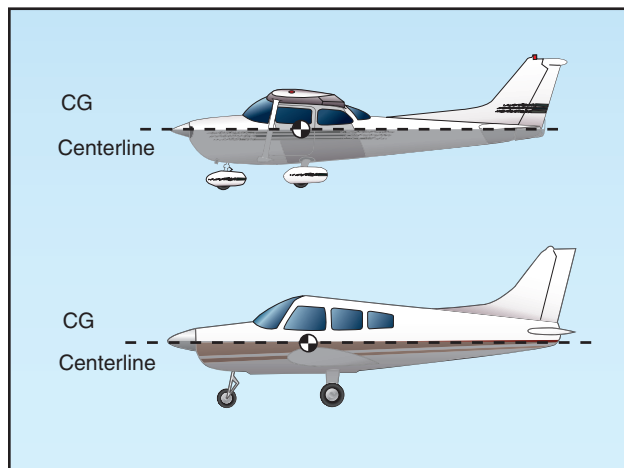

Figure 3-18. Keel area for lateral stability.

### VERTICAL STABILITY (YAWING)

Stability about the airplane's vertical axis (the sideways moment) is called yawing or directional stability.

Yawing or directional stability is the more easily achieved stability in airplane design. The area of the vertical fin and the sides of the fuselage aft of the center of gravity are the prime contributors which make the airplane act like the well known weathervane or arrow, pointing its nose into the relative wind.

In examining a weathervane, it can be seen that if exactly the same amount of surface were exposed to the wind in front of the pivot point as behind it, the forces fore and aft would be in balance and little or no directional movement would result. Consequently, it is necessary to have a greater surface aft of the pivot point than forward of it.

Similarly in an airplane, the designer must ensure positive directional stability by making the side surface greater aft than ahead of the center of gravity. [Figure 3-19] To provide more positive stability aside from that provided by the fuselage, a vertical fin is added. The fin acts similar to the feather on an arrow in maintaining straight flight. Like the weathervane and the arrow, the farther aft this fin is placed and the larger its size, the greater the airplane's directional stability.

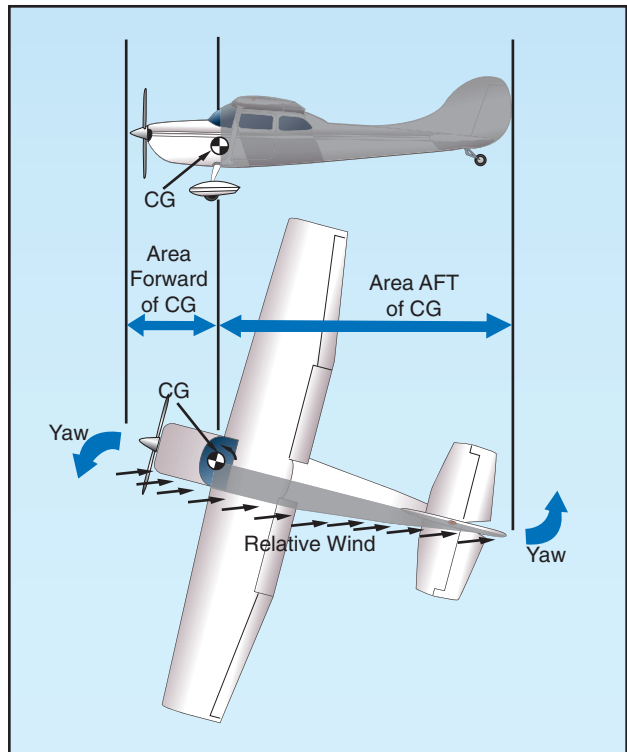

Figure 3-19. Fuselage and fin for vertical stability.

If an airplane is flying in a straight line, and a side-ward gust of air gives the airplane a slight rotation about its vertical axis (i.e., the right), the motion is retarded and stopped by the fin because while the airplane is rotating to the right, the air is striking the left side of the fin at an angle. This causes pressure on the left side of the fin, which resists the turning motion and slows down the airplane's yaw. In doing so, it acts somewhat like the weathervane by turning the airplane into the relative wind. The initial change in direction of the airplane's flightpath is generally slightly behind its change of heading. Therefore, after a slight yawing of the airplane to the right, there is a brief moment when the airplane is still moving along its original path, but its longitudinal axis is pointed slightly to the right.

The airplane is then momentarily skidding sideways, and during that moment (since it is assumed that although the yawing motion has stopped, the excess pressure on the left side of the fin still persists) there

is necessarily a tendency for the airplane to be turned partially back to the left. That is, there is a momentary restoring tendency caused by the fin.

This restoring tendency is relatively slow in developing and ceases when the airplane stops skidding. When it ceases, the airplane will be flying in a direction slightly different from the original direction. In other words, it will not of its own accord return to the original heading; the pilot must reestablish the initial heading.

A minor improvement of directional stability may be obtained through sweepback. Sweepback is incorporated in the design of the wing primarily to delay the onset of compressibility during high-speed flight. In lighter and slower airplanes, sweepback aids in locating the center of pressure in the correct relationship with the center of gravity. A longitudinally stable airplane is built with the center of pressure aft of the center of gravity.

Because of structural reasons, airplane designers sometimes cannot attach the wings to the fuselage at the exact desired point. If they had to mount the wings too far forward, and at right angles to the fuselage, the center of pressure would not be far enough to the rear to result in the desired amount of longitudinal stability. By building sweepback into the wings, however, the designers can move the center of pressure toward the rear. The amount of sweepback and the position of the wings then place the center of pressure in the correct location.

The contribution of the wing to static directional stability is usually small. The swept wing provides a stable contribution depending on the amount of sweepback, but the contribution is relatively small when compared with other components.

### **FREE DIRECTIONAL OSCILLATIONS (DUTCH ROLL)**

Dutch Roll is a coupled lateral/directional oscillation that is usually dynamically stable but is objectionable in an airplane because of the oscillatory nature. The damping of the oscillatory mode may be weak or strong depending on the properties of the particular airplane.

Unfortunately all air is not smooth. There are bumps and depressions created by gusty updrafts and downdrafts, and by gusts from ahead, behind, or the side of the airplane.

The response of the airplane to a disturbance from equilibrium is a combined rolling/yawing oscillation in which the rolling motion is phased to precede the yawing motion. The yawing motion is not too

significant, but the roll is much more noticeable. When the airplane rolls back toward level flight in response to dihedral effect, it rolls back too far and sideslips the other way. Thus, the airplane overshoots each time because of the strong dihedral effect. When the dihedral effect is large in comparison with static directional stability, the Dutch Roll motion has weak damping and is objectionable. When the static directional stability is strong in comparison with the dihedral effect, the Dutch Roll motion has such heavy damping that it is not objectionable. However, these qualities tend toward spiral instability.

The choice is then the least of two evils—Dutch Roll is objectionable and spiral instability is tolerable if the rate of divergence is low. Since the more important handling qualities are a result of high static directional stability and minimum necessary dihedral effect, most airplanes demonstrate a mild spiral tendency. This tendency would be indicated to the pilot by the fact that the airplane cannot be flown “hands off” indefinitely.

In most modern airplanes, except high-speed swept wing designs, these free directional oscillations usually die out automatically in a very few cycles unless the air continues to be gusty or turbulent. Those airplanes with continuing Dutch Roll tendencies usually are equipped with gyro stabilized yaw dampers. An airplane that has Dutch Roll tendencies is disconcerting, to say the least. Therefore, the manufacturer tries to reach a medium between too much and too little directional stability. Because it is more desirable for the airplane to have “spiral instability” than Dutch Roll tendencies, most airplanes are designed with that characteristic.

### **SPIRAL INSTABILITY**

Spiral instability exists when the static directional stability of the airplane is very strong as compared to the effect of its dihedral in maintaining lateral equilibrium. When the lateral equilibrium of the airplane is disturbed by a gust of air and a sideslip is introduced, the strong directional stability tends to yaw the nose into the resultant relative wind while the comparatively weak dihedral lags in restoring the lateral balance. Due to this yaw, the wing on the outside of the turning moment travels forward faster than the inside wing and as a consequence, its lift becomes greater. This produces an overbanking tendency which, if not corrected by the pilot, will result in the bank angle becoming steeper and steeper. At the same time, the strong directional stability that yaws the airplane into the relative wind is actually forcing the nose to a lower pitch attitude. Then, the start of a slow downward



spiral which has begun, if not counteracted by the pilot, will gradually increase into a steep spiral dive. Usually the rate of divergence in the spiral motion is so gradual that the pilot can control the tendency without any difficulty.

All airplanes are affected to some degree by this characteristic although they may be inherently stable in all other normal parameters. This tendency would be indicated to the pilot by the fact that the airplane cannot be flown “hands off” indefinitely.

Much study and effort has gone into development of control devices (wing leveler) to eliminate or at least correct this instability. Advanced stages of this spiral condition demand that the pilot be very careful in application of recovery controls, or excessive loads on the structure may be imposed. Of the in-flight structural failures that have occurred in general aviation airplanes, improper recovery from this condition has probably been the underlying cause of more fatalities than any other single factor. The reason is that the airspeed in the spiral condition builds up rapidly, and the application of back elevator force to reduce this speed and to pull the nose up only “tightens the turn,” increasing the load factor. The results of the prolonged uncontrolled spiral are always the same; either in-flight structural failure, crashing into the ground, or both. The most common causes on record for getting into this situation are: loss of horizon reference, inability of the pilot to control the airplane by reference to instruments, or a combination of both.

## AERODYNAMIC FORCES IN FLIGHT MANEUVERS

### FORCES IN TURNS

If an airplane were viewed in straight-and-level flight from the rear [figure 3-20], and if the forces acting on the airplane actually could be seen, two forces (lift and weight)

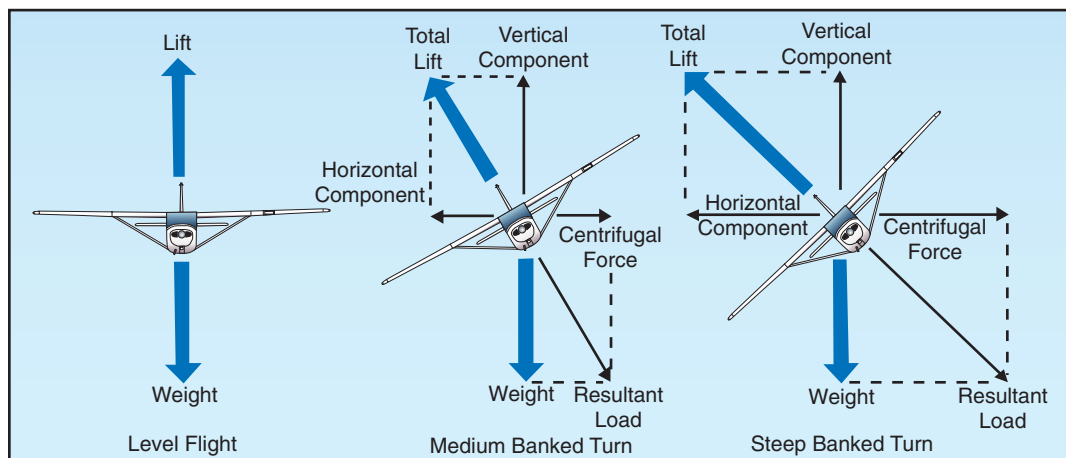

Figure 3-20. Forces during normal coordinated turn.

**Centripetal Force** – The force opposite centrifugal force and attracts a body towards its axis of rotation.

would be apparent, and if the airplane were in a bank it would be apparent that lift did not act directly opposite to the weight—it now acts in the direction of the bank. The fact that when the airplane banks, lift acts inward toward the center of the turn, as well as upward, is one of the basic truths to remember in the consideration of turns.

An object at rest or moving in a straight line will remain at rest or continue to move in a straight line until acted on by some other force. An airplane, like any moving object, requires a sideward force to make it turn. In a normal turn, this force is supplied by banking the airplane so that lift is exerted inward as well as upward. The force of lift during a turn is separated into two components at right angles to each other. One component, which acts vertically and opposite to the weight (gravity), is called the “vertical component of lift.” The other, which acts horizontally toward the center of the turn, is called the “horizontal component of lift,” or **centripetal force**. The horizontal component of lift is the force that pulls the airplane from a straight flightpath to make it turn. **Centrifugal force** is the “equal and opposite reaction” of the airplane to the change in direction and acts equal and opposite to the horizontal component of lift. This explains why, in a correctly executed turn, the force that turns the airplane is not supplied by the rudder.

An airplane is not steered like a boat or an automobile; in order for it to turn, it must be banked. If the airplane is not banked, there is no force available that will cause it to deviate from a straight flightpath. Conversely, when an airplane is banked, it will turn, provided it is not slipping to the inside of the turn. Good directional control is based on the fact that the airplane will attempt to turn whenever it is banked.

**Centrifugal Force**—An apparent force resulting from the effect of inertia during a turn.



This fact should be borne in mind at all times, particularly while attempting to hold the airplane in straight-and-level flight.

Merely banking the airplane into a turn produces no change in the total amount of lift developed. However, as was pointed out, the lift during the bank is divided into two components: one vertical and the other horizontal. This division reduces the amount of lift which is opposing gravity and actually supporting the airplane's weight; consequently, the airplane loses altitude unless additional lift is created. This is done by increasing the angle of attack until the vertical component of lift is again equal to the weight. Since the vertical component of lift decreases as the bank angle increases, the angle of attack must be progressively increased to produce sufficient vertical lift to support the airplane's weight. The fact that the vertical component of lift must be equal to the weight to maintain altitude is an important fact to remember when making constant altitude turns.

At a given airspeed, the rate at which an airplane turns depends upon the magnitude of the horizontal component of lift. It will be found that the horizontal component of lift is proportional to the angle of bank—that is, it increases or decreases respectively as the angle of bank increases or decreases. It logically follows then, that as the angle of bank is increased the horizontal component of lift increases, thereby increasing the rate of turn. Consequently, at any given airspeed the rate of turn can be controlled by adjusting the angle of bank.

To provide a vertical component of lift sufficient to hold altitude in a level turn, an increase in the angle of attack is required. Since the drag of the airfoil is directly proportional to its angle of attack, induced drag will increase as the lift is increased. This, in turn, causes a loss of airspeed in proportion to the

angle of bank; a small angle of bank results in a small reduction in airspeed and a large angle of bank results in a large reduction in airspeed. Additional thrust (power) must be applied to prevent a reduction in airspeed in level turns; the required amount of additional thrust is proportional to the angle of bank.

To compensate for added lift, which would result if the airspeed were increased during a turn, the angle of attack must be decreased, or the angle of bank increased, if a constant altitude were to be maintained. If the angle of bank were held constant and the angle of attack decreased, the rate of turn would decrease. Therefore, in order to maintain a constant rate of turn as the airspeed is increased, the angle of attack must remain constant and the angle of bank increased.

It must be remembered that an increase in airspeed results in an increase of the turn radius and that centrifugal force is directly proportional to the radius of the turn. In a correctly executed turn, the horizontal component of lift must be exactly equal and opposite to the centrifugal force. Therefore, as the airspeed is increased in a constant rate level turn, the radius of the turn increases. This increase in the radius of turn causes an increase in the centrifugal force, which must be balanced by an increase in the horizontal component of lift, which can only be increased by increasing the angle of bank.

In a slipping turn, the airplane is not turning at the rate appropriate to the bank being used, since the airplane is yawed toward the outside of the turning flightpath. The airplane is banked too much for the rate of turn, so the horizontal lift component is greater than the centrifugal force. [Figure 3-21] Equilibrium between the horizontal lift component and centrifugal force is reestablished either by

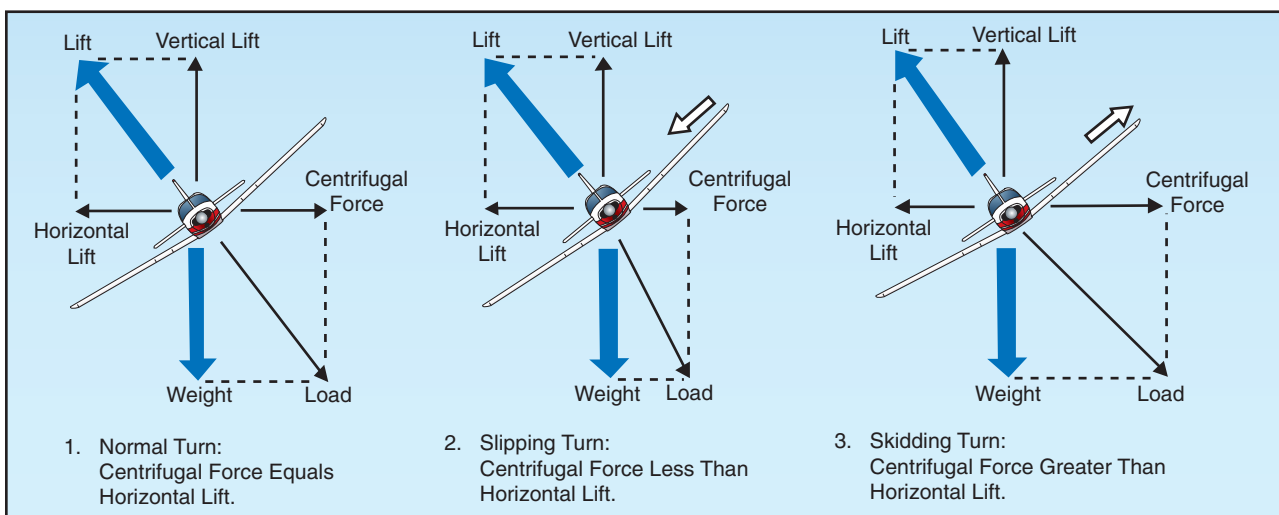

Figure 3-21. Normal, sloping, and skidding turns.

decreasing the bank, increasing the rate of turn, or a combination of the two changes.

A skidding turn results from an excess of centrifugal force over the horizontal lift component, pulling the airplane toward the outside of the turn. The rate of turn is too great for the angle of bank. Correction of a skidding turn thus involves a reduction in the rate of turn, an increase in bank, or a combination of the two changes.

To maintain a given rate of turn, the angle of bank must be varied with the airspeed. This becomes particularly important in high-speed airplanes. For instance, at 400 miles per hour (m.p.h.), an airplane must be banked approximately  $44^\circ$  to execute a standard rate turn ( $3^\circ$  per second). At this angle of bank, only about 79 percent of the lift of the airplane comprises the vertical component of the lift; the result is a loss of altitude unless the angle of attack is increased sufficiently to compensate for the loss of vertical lift.

### FORCES IN CLIMBS

For all practical purposes, the wing's lift in a steady state normal climb is the same as it is in a steady level flight at the same airspeed. Though the airplane's flightpath has changed when the climb has been established, the angle of attack of the wing with respect to the inclined flightpath reverts to practically the same values, as does the lift. There is an initial momentary change, however, as shown in figure 3-22. During the transition from straight-and-level flight to a climb, a change in lift occurs when back elevator pressure is first applied. Raising the airplane's nose increases the angle of attack and momentarily increases the lift. Lift at this moment is now greater than weight and starts the airplane climbing. After the flightpath is stabilized on the upward incline, the angle of attack and lift again revert to about the level flight values.

If the climb is entered with no change in power setting, the airspeed gradually diminishes because the

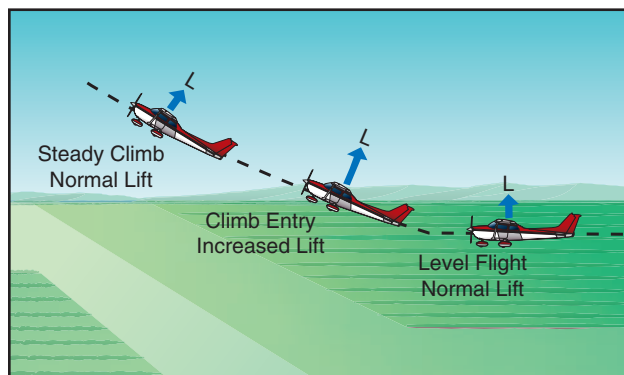

Figure 3-22. Changes in lift during climb entry.

thrust required to maintain a given airspeed in level flight is insufficient to maintain the same airspeed in a climb. When the flightpath is inclined upward, a component of the airplane's weight acts in the same direction as, and parallel to, the total drag of the airplane, thereby increasing the total effective drag. Consequently, the total drag is greater than the power, and the airspeed decreases. The reduction in airspeed gradually results in a corresponding decrease in drag until the total drag (including the component of weight acting in the same direction) equals the thrust. [Figure 3-23] Due to momentum, the change in airspeed is gradual, varying considerably with differences in airplane size, weight, total drag, and other factors.

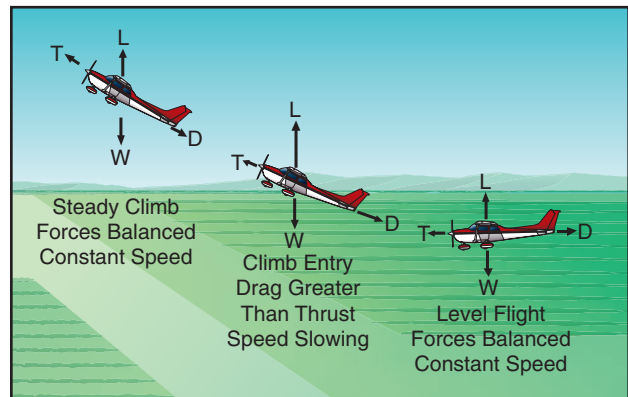

Figure 3-23. Changes in speed during climb entry.

Generally, the forces of thrust and drag, and lift and weight, again become balanced when the airspeed stabilizes but at a value lower than in straight-and-level flight at the same power setting. Since in a climb the airplane's weight is not only acting downward but rearward along with drag, additional power is required to maintain the same airspeed as in level flight. The amount of power depends on the angle of climb. When the climb is established so steep that there is insufficient power available, a slower speed results. It will be seen then that the amount of reserve power determines the climb performance of the airplane.

### FORCES IN DESCENTS

As in climbs, the forces acting on the airplane go through definite changes when a descent is entered from straight-and-level flight. The analysis here is that of descending at the same power as used in straight-and-level flight.

When forward pressure is applied to the elevator control to start descending, or the airplane's nose is allowed to pitch down, the angle of attack is decreased and, as a result, the lift of the airfoil is reduced. This reduction in total lift and angle of attack is momentary and occurs during the time the

flightpath changes downward. The change to a downward flightpath is due to the lift momentarily becoming less than the weight of the airplane as the angle of attack is reduced. This imbalance between lift and weight causes the airplane to follow a descending flightpath with respect to the horizontal flightpath of straight-and-level flight. When the flightpath is in a steady descent, the airfoil's angle of attack again approaches the original value, and lift and weight will again become stabilized. From the time the descent is started until it is stabilized, the airspeed will gradually increase. This is due to a component of weight now acting forward along the flightpath, similar to the manner it acted rearward in a climb. The overall effect is that of increased power or thrust, which in turn causes the increase in airspeed associated with descending at the same power as used in level flight.

To descend at the same airspeed as used in straight-and-level flight, obviously, the power must be reduced as the descent is entered. The component of weight acting forward along the flightpath will increase as the angle of rate of descent increases and conversely, will decrease as the angle of rate of descent decreases. Therefore, the amount of power reduction required for a descent at the same speed as cruise will be determined by the steepness of the descent.

## STALLS

An airplane will fly as long as the wing is creating sufficient lift to counteract the load imposed on it. When the lift is completely lost, the airplane stalls.

Remember, the direct cause of every stall is an excessive angle of attack. There are any number of flight maneuvers which may produce an increase in the angle of attack, but the stall does not occur until the angle of attack becomes excessive.

It must be emphasized that the stalling speed of a particular airplane is not a fixed value for all flight situations. However, a given airplane will always stall at the same angle of attack regardless of airspeed, weight, load factor, or density altitude. Each airplane has a particular angle of attack where the airflow separates from the upper surface of the wing and the stall occurs. This critical angle of attack varies from  $16^\circ$  to  $20^\circ$  depending on the airplane's design. But each airplane has only one specific angle of attack where the stall occurs.

There are three situations in which the critical angle of attack can be exceeded: in low-speed flying, in high-speed flying, and in turning flight.

The airplane can be stalled in straight-and-level flight by flying too slowly. As the airspeed is being

decreased, the angle of attack must be increased to retain the lift required for maintaining altitude. The slower the airspeed becomes, the more the angle of attack must be increased. Eventually, an angle of attack is reached which will result in the wing not producing enough lift to support the airplane and it will start settling. If the airspeed is reduced further, the airplane will stall, since the angle of attack has exceeded the critical angle and the airflow over the wing is disrupted.

It must be reemphasized here that low speed is not necessary to produce a stall. The wing can be brought into an excessive angle of attack at any speed. For example, take the case of an airplane which is in a dive with an airspeed of 200 knots when suddenly the pilot pulls back sharply on the elevator control. [Figure 3-24] Because of gravity and centrifugal force, the airplane could not immediately alter its flightpath but would merely change its angle of attack abruptly from quite low to very high. Since the flightpath of the airplane in relation to the oncoming air determines the direction of the relative wind, the angle of attack is suddenly increased, and the airplane would quickly reach the stalling angle at a speed much greater than the normal stall speed.

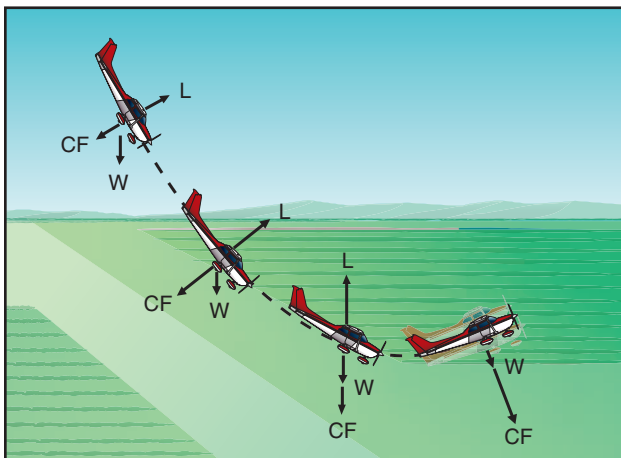

Figure 3-24. Forces exerted when pulling out of a dive.

Similarly, the stalling speed of an airplane is higher in a level turn than in straight-and-level flight. [Figure 3-25] This is because centrifugal force is added to the airplane's weight, and the wing must produce sufficient additional lift to counterbalance the load imposed by the combination of centrifugal force and weight. In a turn, the necessary additional lift is acquired by applying back pressure to the elevator control. This increases the wing's angle of attack, and results in increased lift. The angle of attack must increase as the bank angle increases to counteract the increasing load caused by centrifugal force. If at any time during a turn the angle of attack becomes excessive, the airplane will stall.

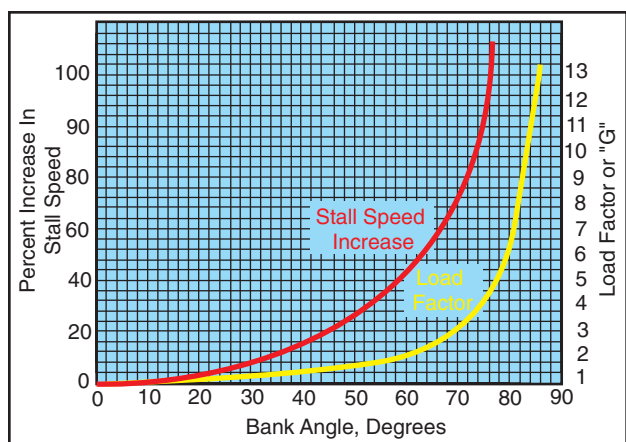

Figure 3-25. Increase in stall speed and load factor.

At this point, the action of the airplane during a stall should be examined. To balance the airplane aerodynamically, the center of lift is normally located aft of the center of gravity. Although this makes the airplane inherently “nose heavy,” downwash on the horizontal stabilizer counteracts this condition. It can be seen then, that at the point of stall when the upward force of the wing’s lift and the downward tail force cease, an unbalanced condition exists. This allows the airplane to pitch down abruptly, rotating about its center of gravity. During this nose-down attitude, the angle of attack decreases and the airspeed again increases; hence, the smooth flow of air over the wing begins again, lift returns, and the airplane is again flying. However, considerable altitude may be lost before this cycle is complete.

## BASIC PROPELLER PRINCIPLES

The airplane propeller consists of two or more blades and a central hub to which the blades are attached. Each blade of an airplane propeller is essentially a rotating wing. As a result of their construction, the propeller blades are like airfoils and produce forces that create the thrust to pull, or push, the airplane through the air.

The power needed to rotate the propeller blades is furnished by the engine. The engine rotates the airfoils of the blades through the air at high speeds, and the propeller transforms the rotary power of the engine into forward thrust.

An airplane moving through the air creates a drag force opposing its forward motion. Consequently, if an airplane is to fly, there must be a force applied to it that is equal to the drag, but acting forward. This force is called “thrust.”

A cross section of a typical propeller blade is shown in figure 3-26. This section or blade element is an

airfoil comparable to a cross section of an airplane wing. One surface of the blade is cambered or curved, similar to the upper surface of an airplane wing, while the other surface is flat like the bottom surface of a wing. The chord line is an imaginary line drawn through the blade from its leading edge to its trailing edge. As in a wing, the leading edge is the thick edge of the blade that meets the air as the propeller rotates.

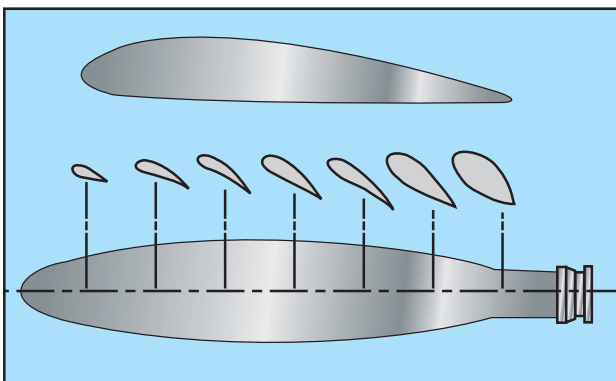

Figure 3-26. Airfoil sections of propeller blade.

Blade angle, usually measured in degrees, is the angle between the chord of the blade and the plane of rotation [figure 3-27] and is measured at a specific point along the length of the blade. Because most propellers have a flat blade “face,” the chord line is often drawn along the face of the propeller blade. Pitch is not the same as blade angle, but because pitch is largely determined by blade angle, the two terms are often used interchangeably. An increase or decrease in one is usually associated with an increase or decrease in the other.

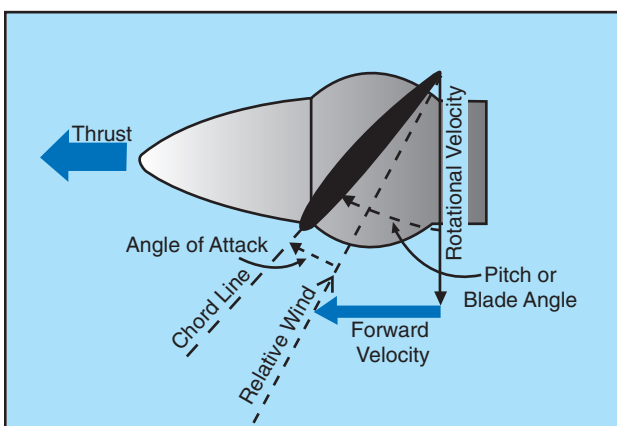

Figure 3-27. Propeller blade angle.

The pitch of a propeller may be designated in inches. A propeller designated as a “74-48” would be 74 inches in length and have an effective pitch of 48 inches. The pitch in inches is the distance which the propeller would screw through the air in one revolution if there were no slippage.



When specifying a fixed-pitch propeller for a new type of airplane, the manufacturer usually selects one with a pitch that will operate efficiently at the expected cruising speed of the airplane. Unfortunately, however, every fixed-pitch propeller must be a compromise, because it can be efficient at only a given combination of airspeed and r.p.m. Pilots do not have it within their power to change this combination in flight.

When the airplane is at rest on the ground with the engine operating, or moving slowly at the beginning of takeoff, the propeller efficiency is very low because the propeller is restrained from advancing with sufficient speed to permit its fixed-pitch blades to reach their full efficiency. In this situation, each propeller blade is turning through the air at an angle of attack that produces relatively little thrust for the amount of power required to turn it.

To understand the action of a propeller, consider first its motion, which is both rotational and forward. Thus, as shown by the vectors of propeller forces in figure 3-27, each section of a propeller blade moves downward and forward. The angle at which this air (relative wind) strikes the propeller blade is its angle of attack. The air deflection produced by this angle causes the dynamic pressure at the engine side of the propeller blade to be greater than atmospheric, thus creating thrust.

The shape of the blade also creates thrust, because it is cambered like the airfoil shape of a wing. Consequently, as the air flows past the propeller, the pressure on one side is less than that on the other. As in a wing, this produces a reaction force in the direction of the lesser pressure. In the case of a wing, the airflow over the wing has less pressure, and the force (lift) is upward. In the case of the propeller, which is mounted in a vertical instead of a horizontal plane, the area of decreased pressure is in front of the propeller, and the force (thrust) is in a forward direction. Aerodynamically, then, thrust is the result of the propeller shape and the angle of attack of the blade.

Another way to consider thrust is in terms of the mass of air handled by the propeller. In these terms, thrust is equal to the mass of air handled, times the slipstream velocity, minus the velocity of the airplane. The power expended in producing thrust depends on the rate of air mass movement. On the average, thrust constitutes approximately 80 percent of the torque (total horsepower absorbed by the propeller). The other 20 percent is lost in friction and slippage. For any speed of rotation, the horsepower absorbed by the propeller balances the horsepower delivered by the engine. For any single revolution of the propeller, the

amount of air handled depends on the blade angle, which determines how big a “bite” of air the propeller takes. Thus, the blade angle is an excellent means of adjusting the load on the propeller to control the engine r.p.m.

The blade angle is also an excellent method of adjusting the angle of attack of the propeller. On constant-speed propellers, the blade angle must be adjusted to provide the most efficient angle of attack at all engine and airplane speeds. Lift versus drag curves, which are drawn for propellers as well as wings, indicate that the most efficient angle of attack is a small one varying from  $2^\circ$  to  $4^\circ$  positive. The actual blade angle necessary to maintain this small angle of attack varies with the forward speed of the airplane.

Fixed-pitch and ground-adjustable propellers are designed for best efficiency at one rotation and forward speed. They are designed for a given airplane and engine combination. A propeller may be used that provides the maximum propeller efficiency for either takeoff, climb, cruise, or high-speed flight. Any change in these conditions results in lowering the efficiency of both the propeller and the engine. Since the efficiency of any machine is the ratio of the useful power output to the actual power input, propeller efficiency is the ratio of thrust horsepower to brake horsepower. Propeller efficiency varies from 50 to 87 percent, depending on how much the propeller “slips.”

Propeller slip is the difference between the geometric pitch of the propeller and its effective pitch. [Figure 3-28] Geometric pitch is the theoretical distance a propeller should advance in one revolution; effective pitch is the distance it actually advances. Thus, geometric or theoretical pitch is based on no slippage, but actual or effective pitch includes propeller slippage in the air.

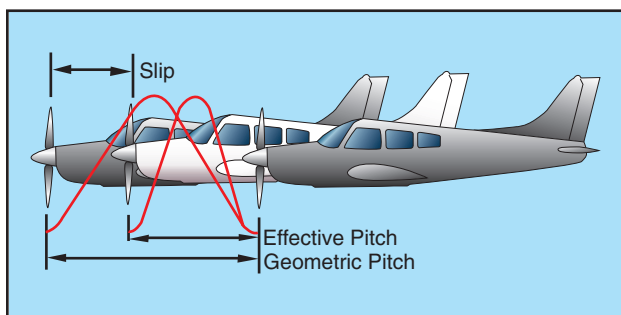

Figure 3-28. Propeller slippage.

The reason a propeller is “twisted” is that the outer parts of the propeller blades, like all things that turn about a central point, travel faster than the portions near the hub. [Figure 3-29] If the blades had the



same geometric pitch throughout their lengths, at cruise speed the portions near the hub could have negative angles of attack while the propeller tips would be stalled. “Twisting,” or variations in the geometric pitch of the blades, permits the propeller to operate with a relatively constant angle of attack along its length when in cruising flight. To put it another way, propeller blades are twisted to change the blade angle in proportion to the differences in speed of rotation along the length of the propeller and thereby keep thrust more nearly equalized along this length.

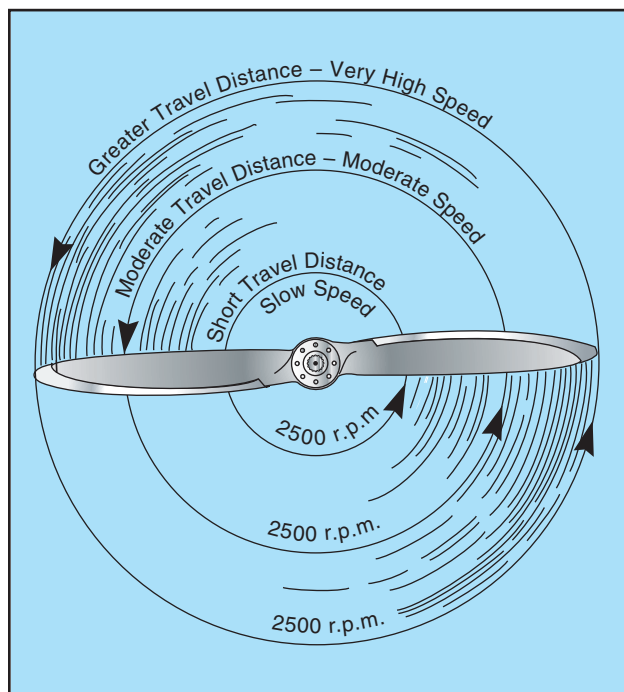

Figure 3-29. Propeller tips travel faster than hubs.

Usually  $1^\circ$  to  $4^\circ$  provides the most efficient lift/drag ratio, but in flight the propeller angle of attack of a fixed-pitch propeller will vary—normally from  $0^\circ$  to  $15^\circ$ . This variation is caused by changes in the relative airstream which in turn results from changes in airplane speed. In short, propeller angle of attack is the product of two motions: propeller rotation about its axis and its forward motion.

A constant-speed propeller, however, automatically keeps the blade angle adjusted for maximum efficiency for most conditions encountered in flight. During takeoff, when maximum power and thrust are required, the constant-speed propeller is at a low propeller blade angle or pitch. The low blade angle keeps the angle of attack small and efficient with respect to the relative wind. At the same time, it allows the propeller to handle a smaller mass of air per revolution. This light load allows the engine to turn at high r.p.m. and to convert the maximum amount of fuel into heat energy in a given time. The

high r.p.m. also creates maximum thrust; for, although the mass of air handled per revolution is small, the number of revolutions per minute is many, the slipstream velocity is high, and with the low airplane speed, the thrust is maximum.

After liftoff, as the speed of the airplane increases, the constant-speed propeller automatically changes to a higher angle (or pitch). Again, the higher blade angle keeps the angle of attack small and efficient with respect to the relative wind. The higher blade angle increases the mass of air handled per revolution. This decreases the engine r.p.m., reducing fuel consumption and engine wear, and keeps thrust at a maximum.

After the takeoff climb is established in an airplane having a controllable-pitch propeller, the pilot reduces the power output of the engine to climb power by first decreasing the manifold pressure and then increasing the blade angle to lower the r.p.m.

At cruising altitude, when the airplane is in level flight and less power is required than is used in takeoff or climb, the pilot again reduces engine power by reducing the manifold pressure and then increasing the blade angle to decrease the r.p.m. Again, this provides a torque requirement to match the reduced engine power; for, although the mass of air handled per revolution is greater, it is more than offset by a decrease in slipstream velocity and an increase in airspeed. The angle of attack is still small because the blade angle has been increased with an increase in airspeed.

### TORQUE AND P FACTOR

To the pilot, “torque” (the left turning tendency of the airplane) is made up of four elements which cause or produce a twisting or rotating motion around at least one of the airplane’s three axes. These four elements are:

1. Torque Reaction from Engine and Propeller.
2. Corkscrewing Effect of the Slipstream.
3. Gyroscopic Action of the Propeller.
4. Asymmetric Loading of the Propeller (P Factor).

### TORQUE REACTION

Torque reaction involves Newton’s Third Law of Physics—for every action, there is an equal and opposite reaction. As applied to the airplane, this means that as the internal engine parts and propeller are revolving in one direction, an equal force is trying to rotate the airplane in the opposite direction. [Figure 3-30]

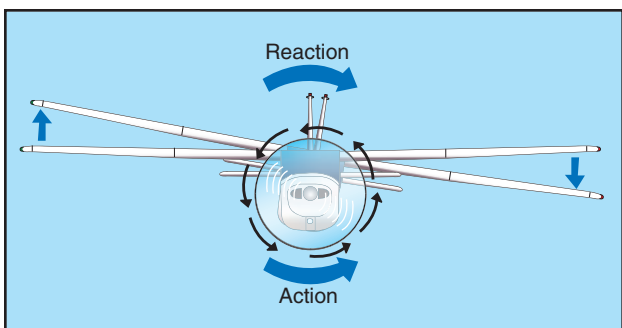

Figure 3-30. Torque reaction.

When the airplane is airborne, this force is acting around the longitudinal axis, tending to make the airplane roll. To compensate for this, some of the older airplanes are rigged in a manner to create more lift on the wing that is being forced downward. The more modern airplanes are designed with the engine offset to counteract this effect of torque.

*NOTE—Most United States built aircraft engines rotate the propeller clockwise, as viewed from the pilot's seat. The discussion here is with reference to those engines.*

Generally, the compensating factors are permanently set so that they compensate for this force at cruising speed, since most of the airplane's operating lift is at that speed. However, aileron trim tabs permit further adjustment for other speeds.

When the airplane's wheels are on the ground during the takeoff roll, an additional turning moment around the vertical axis is induced by torque reaction. As the left side of the airplane is being forced down by torque reaction, more weight is being placed on the left main landing gear. This results in more ground friction, or drag, on the left tire than on the right, causing a further turning moment to the left. The magnitude of this moment is dependent on many variables. Some of these variables are: (1) size and horsepower of engine, (2) size of propeller and the r.p.m., (3) size of the airplane, and (4) condition of the ground surface.

This yawing moment on the takeoff roll is corrected by the pilot's proper use of the rudder or rudder trim.

### CORKSCREW EFFECT

The high-speed rotation of an airplane propeller gives a corkscrew or spiraling rotation to the slipstream. At high propeller speeds and low forward speed (as in the takeoffs and approaches to power-on stalls), this spiraling rotation is very compact and exerts a strong sideward force on the airplane's vertical tail surface. [Figure 3-31]

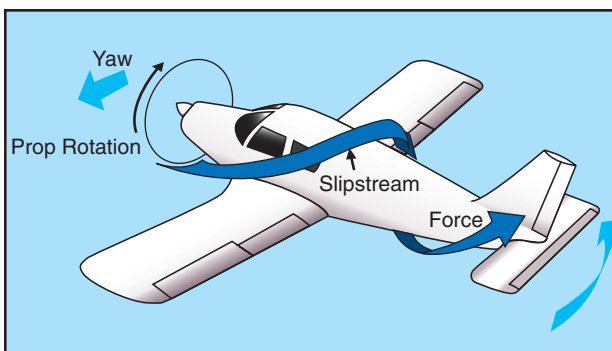

Figure 3-31. Corkscrewing slipstream.

When this spiraling slipstream strikes the vertical fin on the left, it causes a left turning moment about the airplane's vertical axis. The more compact the spiral, the more prominent this force is. As the forward speed increases, however, the spiral elongates and becomes less effective.

The corkscrew flow of the slipstream also causes a rolling moment around the longitudinal axis.

Note that this rolling moment caused by the corkscrew flow of the slipstream is to the right, while the rolling moment caused by torque reaction is to the left—in effect one may be counteracting the other. However, these forces vary greatly and it is up to the pilot to apply proper correction action by use of the flight controls at all times. These forces must be counteracted regardless of which is the most prominent at the time.

### GYROSCOPIC ACTION

Before the gyroscopic effects of the propeller can be understood, it is necessary to understand the basic principle of a gyroscope.

All practical applications of the gyroscope are based upon two fundamental properties of gyroscopic action: rigidity in space and precession. The one of interest for this discussion is precession.

Precession is the resultant action, or deflection, of a spinning rotor when a deflecting force is applied to its rim. As can be seen in figure 3-32, when a force is applied, the resulting force takes effect 90° ahead of and in the direction of rotation.

The rotating propeller of an airplane makes a very good gyroscope and thus has similar properties. Any time a force is applied to deflect the propeller out of its plane of rotation, the resulting force is 90° ahead of and in the direction of rotation and in the direction of application, causing a pitching moment, a yawing moment, or a combination of the two depending upon the point at which the force was applied.

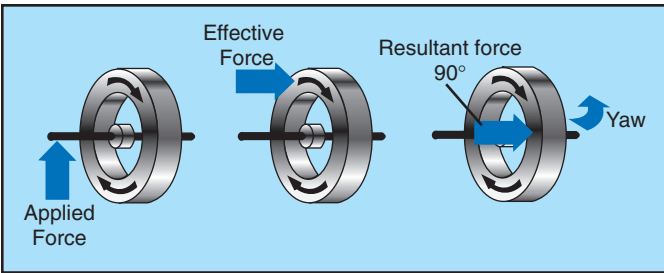

Figure 3-32. Gyroscopic precession.

This element of torque effect has always been associated with and considered more prominent in tailwheel-type airplanes, and most often occurs when the tail is being raised during the takeoff roll. [Figure 3-33] This change in pitch attitude has the same effect as applying a force to the top of the propeller's plane of rotation. The resultant force acting  $90^\circ$  ahead causes a yawing moment to the left around the vertical axis. The magnitude of this moment depends on several variables, one of which is the abruptness with which the tail is raised (amount of force applied). However, precession, or gyroscopic action, occurs when a force is applied to any point on the rim of the propeller's plane of rotation; the resultant force will still be  $90^\circ$  from the point of application in the direction of rotation. Depending on where the force is applied, the airplane is caused to yaw left or right, to pitch up or down, or a combination of pitching and yawing.

It can be said that as a result of gyroscopic action—any yawing around the vertical axis results in a pitching moment, and any pitching around the lateral axis results in a yawing moment.

To correct for the effect of gyroscopic action, it is necessary for the pilot to properly use elevator and rudder to prevent undesired pitching and yawing.

#### ASYMMETRIC LOADING (P FACTOR)

When an airplane is flying with a high angle of attack, the “bite” of the downward moving blade is

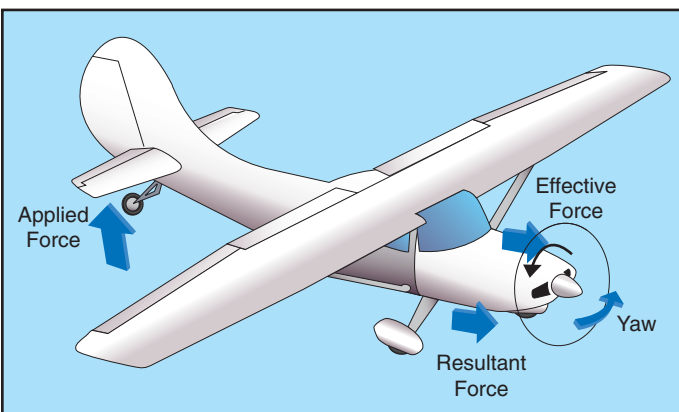

Figure 3-33. Raising tail produces gyroscopic precession.

greater than the “bite” of the upward moving blade; thus moving the center of thrust to the right of the prop disc area—causing a yawing moment toward the left around the vertical axis. That explanation is correct; however, to prove this phenomenon, it would be necessary to work wind vector problems on each blade, which gets quite involved when considering both the angle of attack of the airplane and the angle of attack of each blade.

This asymmetric loading is caused by the resultant velocity, which is generated by the combination of the velocity of the propeller blade in its plane of rotation and the velocity of the air passing horizontally through the propeller “disc.” With the airplane being flown at positive angles of attack, the right (viewed from the rear) or downswinging blade, is passing through an area of resultant velocity which is greater than that affecting the left or upswinging blade. Since the propeller blade is an airfoil, increased velocity means increased lift. Therefore, the downswinging blade having more “lift” tends to pull (yaw) the airplane's nose to the left.

Simply stated, when the airplane is flying at a high angle of attack, the downward moving blade has a higher resultant velocity; therefore creating more lift than the upward moving blade. [Figure 3-34] This might be easier to visualize if the propeller shaft was

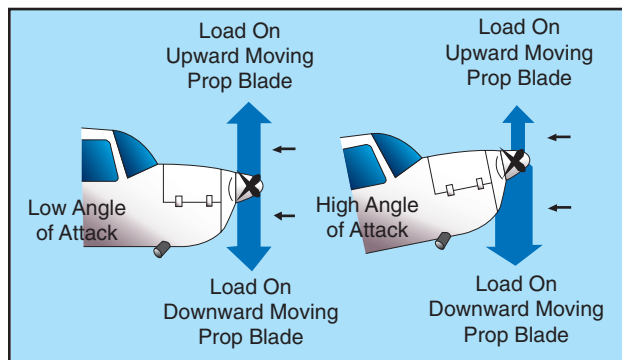

Figure 3-34. Asymmetrical loading of propeller (P-factor).

mounted perpendicular to the ground (like a helicopter). If there were no air movement at all, except that generated by the propeller itself, identical sections of each blade would have the same airspeed. However, with air moving horizontally across this vertically mounted propeller, the blade proceeding forward into the flow of air will have a higher airspeed than the blade retreating with the airflow. Thus, the blade proceeding into the horizontal airflow is creating more lift, or thrust, moving the center of thrust toward that blade. Visualize ROTATING the vertically mounted propeller shaft to shallower

angles relative to the moving air (as on an airplane). This unbalanced thrust then becomes proportionately smaller and continues getting smaller until it reaches the value of zero when the propeller shaft is exactly horizontal in relation to the moving air.

Each of these four elements of torque effects vary in values with changes in flight situations. In one phase of flight, one of these elements may be more prominent than another; whereas, in another phase of flight, another element may be more prominent. The relationship of these values to each other will vary with different airplanes—depending on the AIRFRAME, ENGINE, AND PROPELLER combinations as well as other design features.

To maintain positive control of the airplane in all flight conditions, the pilot must apply the flight controls as necessary to compensate for these varying values.

## LOAD FACTORS

The preceding sections only briefly considered some of the practical points of the principles of flight. To become a pilot, a detailed technical course in the science of aerodynamics is not necessary. However, with responsibilities for the safety of passengers, the competent pilot must have a well-founded concept of the forces which act on the airplane, and the advantageous use of these forces, as well as the operating limitations of the particular airplane. Any force applied to an airplane to deflect its flight from a straight line produces a stress on its structure; the amount of this force is termed “load factor.”

A load factor is the ratio of the total airload acting on the airplane to the gross weight of the airplane. For example, a load factor of 3 means that the total load on an airplane’s structure is three times its gross weight. Load factors are usually expressed in terms of “G”—that is, a load factor of 3 may be spoken of as 3 G’s, or a load factor of 4 as 4 G’s.

It is interesting to note that in subjecting an airplane to 3 G’s in a pullup from a dive, one will be pressed down into the seat with a force equal to three times the person’s weight. Thus, an idea of the magnitude of the load factor obtained in any maneuver can be determined by considering the degree to which one is pressed down into the seat. Since the operating speed of modern airplanes has increased significantly, this effect has become so pronounced that it is a primary consideration in the design of the structure for all airplanes.

With the structural design of airplanes planned to withstand only a certain amount of overload, a

knowledge of load factors has become essential for all pilots. Load factors are important to the pilot for two distinct reasons:

1. Because of the obviously dangerous overload that is possible for a pilot to impose on the airplane structures; and
2. Because an increased load factor increases the stalling speed and makes stalls possible at seemingly safe flight speeds.

## LOAD FACTORS IN AIRPLANE DESIGN

The answer to the question “how strong should an airplane be” is determined largely by the use to which the airplane will be subjected. This is a difficult problem, because the maximum possible loads are much too high for use in efficient design. It is true that any pilot can make a very hard landing or an extremely sharp pullup from a dive, which would result in abnormal loads. However, such extremely abnormal loads must be dismissed somewhat if airplanes are built that will take off quickly, land slowly, and carry a worthwhile payload.

The problem of load factors in airplane design then reduces to that of determining the highest load factors that can be expected in normal operation under various operational situations. These load factors are called “limit load factors.” For reasons of safety, it is required that the airplane be designed to withstand these load factors without any structural damage. Although the Code of Federal Regulations requires that the airplane structure be capable of supporting one and one-half times these limit load factors without failure, it is accepted that parts of the airplane may bend or twist under these loads and that some structural damage may occur.

This 1.5 value is called the “factor of safety” and provides, to some extent, for loads higher than those expected under normal and reasonable operation. However, this strength reserve is not something which pilots should willfully abuse; rather it is there for their protection when they encounter unexpected conditions.

The above considerations apply to all loading conditions, whether they be due to gusts, maneuvers, or landings. The gust load factor requirements now in effect are substantially the same as those that have been in existence for years. Hundreds of thousands of operational hours have proven them adequate for safety. Since the pilot has little control over gust load factors (except to reduce the airplane’s speed when rough air is encountered), the gust loading requirements are substantially the same for most general aviation type airplanes regardless of their



operational use. Generally, the gust load factors control the design of airplanes which are intended for strictly nonacrobatic usage.

An entirely different situation exists in airplane design with maneuvering load factors. It is necessary to discuss this matter separately with respect to: (1) Airplanes which are designed in accordance with the Category System (i.e., Normal, Utility, Acrobatic); and (2) Airplanes of older design which were built to requirements which did not provide for operational categories.

Airplanes designed under the Category System are readily identified by a placard in the cockpit, which states the operational category (or categories) in which the airplane is certificated. The maximum safe load factors (limit load factors) specified for airplanes in the various categories are as follows:

CATEGORY	LIMIT LOAD
Normal <sup>1</sup>	3.8 to -1.52
Utility (mild acrobatics, including spins)	4.4 to -1.76
Acrobatic	6.0 to -3.0

<sup>1</sup> For airplanes with gross weight of more than 4,000 pounds, the limit load factor is reduced. To the limit loads given above, a safety factor of 50 percent is added.

There is an upward graduation in load factor with the increasing severity of maneuvers. The Category System provides for obtaining the maximum utility of an airplane. If normal operation alone is intended, the required load factor (and consequently the weight of the airplane) is less than if the airplane is to be employed in training or acrobatic maneuvers as they result in higher maneuvering loads.

Airplanes that do not have the category placard are designs that were constructed under earlier engineering requirements in which no operational restrictions were specifically given to the pilots. For airplanes of this type (up to weights of about 4,000 pounds) the required strength is comparable to present-day utility category airplanes, and the same types of operation are permissible. For airplanes of this type over 4,000 pounds, the load factors decrease with weight so that these airplanes should be regarded as being comparable to the normal category airplanes designed under the Category System, and they should be operated accordingly.

### LOAD FACTORS IN STEEP TURNS

In a constant altitude, coordinated turn in any airplane, the load factor is the result of two forces: centrifugal force and gravity. [Figure 3-35] For any given bank angle, the rate of turn varies with the

airspeed; the higher the speed, the slower the rate of turn. This compensates for added centrifugal force, allowing the load factor to remain the same.

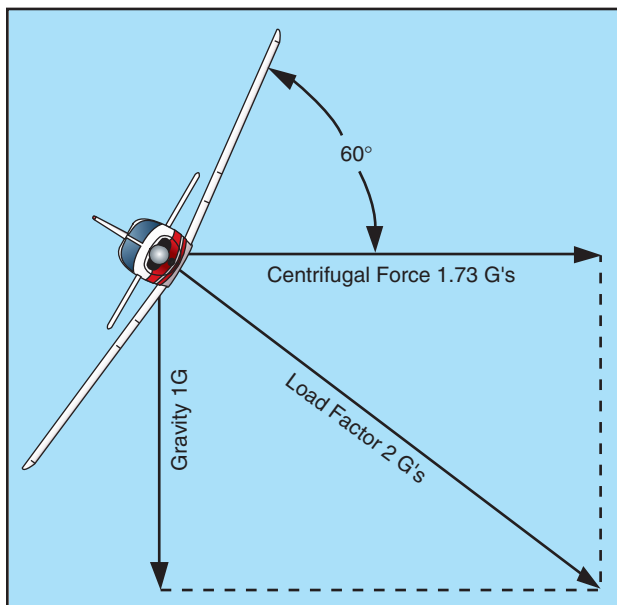

Figure 3-35. Two forces cause load factor during turns.

Figure 3-36 reveals an important fact about turns—that the load factor increases at a terrific rate after a bank has reached 45° or 50°. The load factor for any airplane in a 60° bank is 2 G's. The load factor in an 80° bank is 5.76 G's. The wing must produce lift equal to these load factors if altitude is to be maintained.

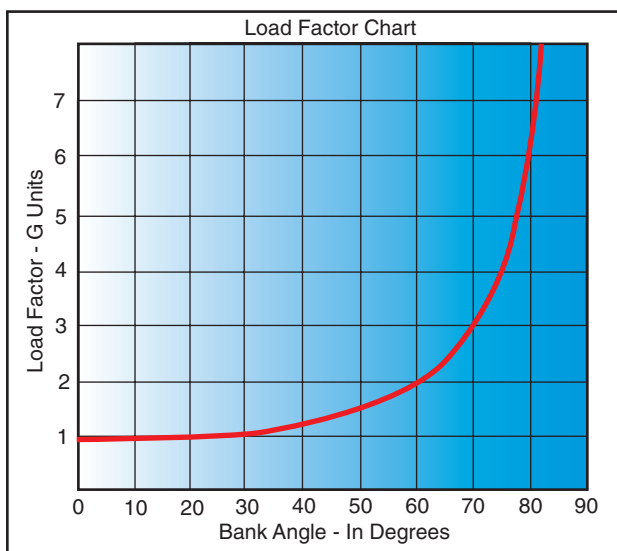

Figure 3-36. Angle of bank changes load factor.

It should be noted how rapidly the line denoting load factor rises as it approaches the 90° bank line, which it reaches only at infinity. The 90° banked, constant altitude turn mathematically is not possible. True, an airplane may be banked to 90° but not in a coordinated turn; an airplane which can be held in a 90°



banked slipping turn is capable of straight knife-edged flight. At slightly more than  $80^\circ$ , the load factor exceeds the limit of 6 G's, the limit load factor of an acrobatic airplane.

For a coordinated, constant altitude turn, the approximate maximum bank for the average general aviation airplane is  $60^\circ$ . This bank and its resultant necessary power setting reach the limit of this type of airplane. An additional  $10^\circ$  bank will increase the load factor by approximately 1 G, bringing it close to the yield point established for these airplanes. [Figure 3-36]

### LOAD FACTORS AND STALLING SPEEDS

Any airplane, within the limits of its structure, may be stalled at any airspeed. When a sufficiently high angle of attack is imposed, the smooth flow of air over an airfoil breaks up and separates, producing an abrupt change of flight characteristics and a sudden loss of lift, which results in a stall.

A study of this effect has revealed that the airplane's stalling speed increases in proportion to the square root of the load factor. This means that an airplane with a normal unaccelerated stalling speed of 50 knots can be stalled at 100 knots by inducing a load factor of 4 G's. If it were possible for this airplane to withstand a load factor of 9, it could be stalled at a speed of 150 knots. Therefore, a competent pilot should be aware of the following:

- The danger of inadvertently stalling the airplane by increasing the load factor, as in a steep turn or spiral; and

- That in intentionally stalling an airplane above its design maneuvering speed, a tremendous load factor is imposed.

Reference to the charts in figures 3-36 and 3-37 will show that by banking the airplane to just beyond  $72^\circ$  in a steep turn produces a load factor of 3, and the stalling speed is increased significantly. If this turn is made in an airplane with a normal unaccelerated stalling speed of 45 knots, the airspeed must be kept above 75 knots to prevent inducing a stall. A similar effect is experienced in a quick pullup, or any maneuver producing load factors above 1 G. This has been the cause of accidents resulting from a sudden, unexpected loss of control, particularly in a steep turn or abrupt application of the back elevator control near the ground.

Since the load factor squares as the stalling speed doubles, it may be realized that tremendous loads may be imposed on structures by stalling an airplane at relatively high airspeeds.

The maximum speed at which an airplane may be stalled safely is now determined for all new designs. This speed is called the "design maneuvering speed" ( $V_A$ ) and is required to be entered in the FAA-approved Airplane Flight Manual or Pilot's Operating Handbook (AFM/POH) of all recently designed airplanes. For older general aviation airplanes, this speed will be approximately 1.7 times the normal stalling speed. Thus, an older airplane which normally stalls at 60 knots must never be stalled at above 102 knots ( $60 \text{ knots} \times 1.7 = 102 \text{ knots}$ ). An airplane with a normal stalling speed of

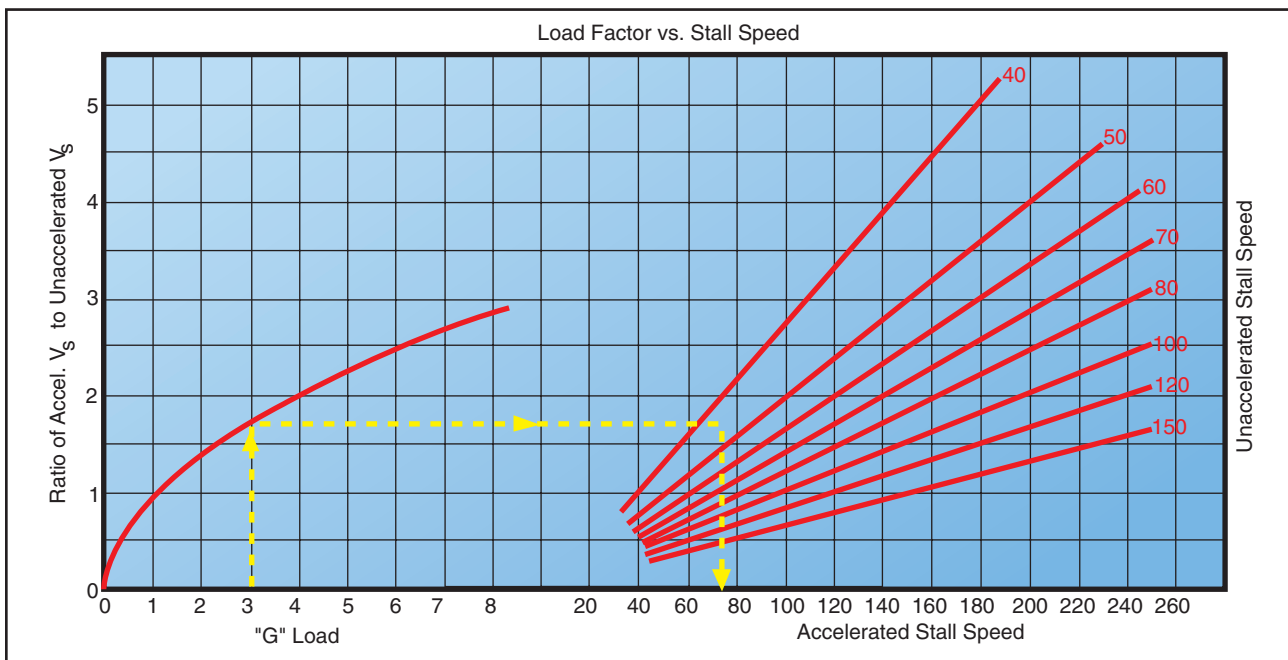

Figure 3-37. Load factor changes stall speed.

60 knots will undergo, when stalled at 102 knots, a load factor equal to the square of the increase in speed or 2.89 G's ( $1.7 \times 1.7 = 2.89$  G's). (The above figures are an approximation to be considered as a guide and are not the exact answers to any set of problems. The design maneuvering speed should be determined from the particular airplane's operating limitations when provided by the manufacturer.)

Since the leverage in the control system varies with different airplanes and some types employ "balanced" control surfaces while others do not, the pressure exerted by the pilot on the controls cannot be accepted as an index of the load factors produced in different airplanes. In most cases, load factors can be judged by the experienced pilot from the feel of seat pressure. They can also be measured by an instrument called an "accelerometer," but since this instrument is not common in general aviation training airplanes, the development of the ability to judge load factors from the feel of their effect on the body is important. A knowledge of the principles outlined above is essential to the development of this ability to estimate load factors.

A thorough knowledge of load factors induced by varying degrees of bank, and the significance of design maneuvering speed ( $V_A$ ) will aid in the prevention of two of the most serious types of accidents:

1. Stalls from steep turns or excessive maneuvering near the ground; and
2. Structural failures during acrobatics or other violent maneuvers resulting from loss of control.

#### **LOAD FACTORS AND FLIGHT MANEUVERS**

Critical load factors apply to all flight maneuvers except unaccelerated straight flight where a load factor of 1 G is always present. Certain maneuvers considered in this section are known to involve relatively high load factors.

**TURNS**—Increased load factors are a characteristic of all banked turns. As noted in the section on load factors in steep turns and particularly figures 3-36 and 3-37, load factors become significant both to flight performance and to the load on wing structure as the bank increases beyond approximately  $45^\circ$ .

The yield factor of the average light plane is reached at a bank of approximately  $70^\circ$  to  $75^\circ$ , and the stalling speed is increased by approximately one-half at a bank of approximately  $63^\circ$ .

**STALLS**—The normal stall entered from straight level flight, or an unaccelerated straight climb, will not produce added load factors beyond the 1 G of

straight-and-level flight. As the stall occurs, however, this load factor may be reduced toward zero, the factor at which nothing seems to have weight; and the pilot has the feeling of "floating free in space." In the event recovery is effected by snapping the elevator control forward, negative load factors, those which impose a down load on the wings and raise the pilot from the seat, may be produced.

During the pullup following stall recovery, significant load factors sometimes are induced. Inadvertently these may be further increased during excessive diving (and consequently high airspeed) and abrupt pullups to level flight. One usually leads to the other, thus increasing the load factor. Abrupt pullups at high diving speeds may impose critical loads on airplane structures and may produce recurrent or secondary stalls by increasing the angle of attack to that of stalling.

As a generalization, a recovery from a stall made by diving only to cruising or design maneuvering airspeed, with a gradual pullup as soon as the airspeed is safely above stalling, can be effected with a load factor not to exceed 2 or 2.5 G's. A higher load factor should never be necessary unless recovery has been effected with the airplane's nose near or beyond the vertical attitude, or at extremely low altitudes to avoid diving into the ground.

**SPINS**—Since a stabilized spin is not essentially different from a stall in any element other than rotation, the same load factor considerations apply as those that apply to stall recovery. Since spin recoveries usually are effected with the nose much lower than is common in stall recoveries, higher airspeeds and consequently higher load factors are to be expected. The load factor in a proper spin recovery will usually be found to be about 2.5 G's.

The load factor during a spin will vary with the spin characteristics of each airplane but is usually found to be slightly above the 1 G of level flight. There are two reasons this is true:

1. The airspeed in a spin is very low, usually within 2 knots of the unaccelerated stalling speeds; and
2. The airplane pivots, rather than turns, while it is in a spin.

**HIGH-SPEED STALLS**—The average light plane is not built to withstand the repeated application of load factors common to high-speed stalls. The load factor necessary for these maneuvers produces a stress on the wings and tail structure, which does not leave a reasonable margin of safety in most light airplanes.

The only way this stall can be induced at an airspeed above normal stalling involves the imposition of an added load factor, which may be accomplished by a severe pull on the elevator control. A speed of 1.7 times stalling speed (about 102 knots in a light airplane with a stalling speed of 60 knots) will produce a load factor of 3 G's. Further, only a very narrow margin for error can be allowed for acrobatics in light airplanes. To illustrate how rapidly the load factor increases with airspeed, a high-speed stall at 112 knots in the same airplane would produce a load factor of 4 G's.

**CHANDELLES AND LAZY EIGHTS**—It would be difficult to make a definite statement concerning load factors in these maneuvers as both involve smooth, shallow dives and pullups. The load factors incurred depend directly on the speed of the dives and the abruptness of the pullups.

Generally, the better the maneuver is performed, the less extreme will be the load factor induced. A chandelle or lazy eight, in which the pullup produces a load factor greater than 2 G's will not result in as great a gain in altitude, and in low-powered airplanes it may result in a net loss of altitude.

The smoothest pullup possible, with a moderate load factor, will deliver the greatest gain in altitude in a chandelle and will result in a better overall performance in both chandelles and lazy eights. Further, it will be noted that recommended entry speed for these maneuvers is generally near the manufacturer's design maneuvering speed, thereby allowing maximum development of load factors without exceeding the load limits.

**ROUGH AIR**—All certificated airplanes are designed to withstand loads imposed by gusts of considerable intensity. Gust load factors increase with increasing airspeed and the strength used for design purposes usually corresponds to the highest level flight speed. In extremely rough air, as in thunderstorms or frontal conditions, it is wise to reduce the speed to the design maneuvering speed. Regardless of the speed held, there may be gusts that can produce loads which exceed the load limits.

Most airplane flight manuals now include turbulent air penetration information. Operators of modern airplanes, capable of a wide range of speeds and altitudes, are benefited by this added feature both in comfort and safety. In this connection, it is to be noted that the maximum "never-exceed" placard dive speeds are determined for smooth air only. High-speed dives or acrobatics involving speed above the known maneuvering speed should never be practiced in rough or turbulent air.

In summary, it must be remembered that load factors induced by intentional acrobatics, abrupt pullups from dives, high-speed stalls, and gusts at high airspeeds all place added stress on the entire structure of an airplane.

Stress on the structure involves forces on any part of the airplane. There is a tendency for the uninformed to think of load factors only in terms of their effect on spars and struts. Most structural failures due to excess load factors involve rib structure within the leading and trailing edges of wings and tail group. The critical area of fabric-covered airplanes is the covering about one-third of the chord aft on the top surface of the wing.

The cumulative effect of such loads over a long period of time may tend to loosen and weaken vital parts so that actual failure may occur later when the airplane is being operated in a normal manner.

### VG DIAGRAM

The flight operating strength of an airplane is presented on a graph whose horizontal scale is based on load factor. [Figure 3-38] The diagram is called a Vg diagram—velocity versus "g" loads or load factor. Each airplane has its own Vg diagram which is valid at a certain weight and altitude.

The lines of maximum lift capability (curved lines) are the first items of importance on the Vg diagram. The subject airplane in the illustration is capable of developing no more than one positive "g" at 62 m.p.h., the wing level stall speed of the airplane. Since the maximum load factor varies with the square of the airspeed, the maximum positive lift capability of this airplane is 2 "g" at 92 m.p.h., 3 "g" at 112 m.p.h., 4.4 "g" at 137 m.p.h., and so forth. Any load factor above this line is unavailable aerodynamically; i.e., the subject airplane cannot fly above the line of maximum lift capability (it will stall). Essentially the same situation exists for negative lift flight with the exception that the speed necessary to produce a given negative load factor is higher than that to produce the same positive load factor.

If the subject airplane is flown at a positive load factor greater than the positive limit load factor of 4.4, structural damage will be possible. When the airplane is operated in this region, objectionable permanent deformation of the primary structure may take place and a high rate of fatigue damage is incurred. Operation above the limit load factor must be avoided in normal operation.

There are two other points of importance on the Vg diagram. First, is the intersection of the positive limit

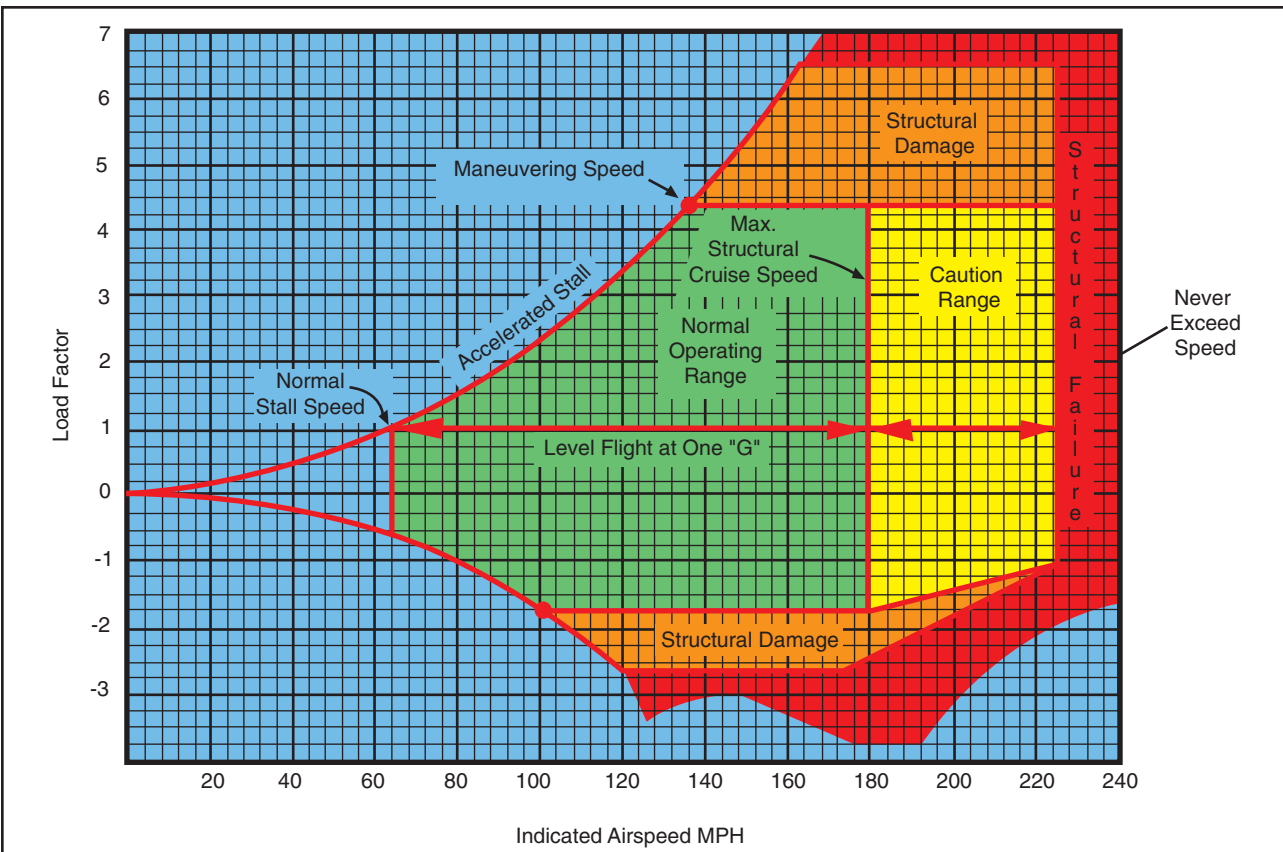

Figure 3-38. Typical Vg diagram.

load factor and the line of maximum positive lift capability. The airspeed at this point is the minimum airspeed at which the limit load can be developed aerodynamically. Any airspeed greater than this provides a positive lift capability sufficient to damage the airplane; any airspeed less does not provide positive lift capability sufficient to cause damage from excessive flight loads. The usual term given to this speed is “maneuvering speed,” since consideration of subsonic aerodynamics would predict minimum usable turn radius to occur at this condition. The maneuver speed is a valuable reference point, since an airplane operating below this point cannot produce a damaging positive flight load. Any combination of maneuver and gust cannot create damage due to excess airload when the airplane is below the maneuver speed.

Next, is the intersection of the negative limit load factor and line of maximum negative lift capability. Any airspeed greater than this provides a negative lift capability sufficient to damage the airplane; any airspeed less does not provide negative lift capability sufficient to damage the airplane from excessive flight loads.

The limit airspeed (or redline speed) is a design reference point for the airplane—the subject airplane is limited to 225 m.p.h. If flight is attempted beyond

the limit airspeed, structural damage or structural failure may result from a variety of phenomena.

Thus, the airplane in flight is limited to a regime of airspeeds and g’s which do not exceed the limit (or redline) speed, do not exceed the limit load factor, and cannot exceed the maximum lift capability. The airplane must be operated within this “envelope” to prevent structural damage and ensure that the anticipated service lift of the airplane is obtained. The pilot must appreciate the Vg diagram as describing the allowable combination of airspeeds and load factors for safe operation. Any maneuver, gust, or gust plus maneuver outside the structural envelope can cause structural damage and effectively shorten the service life of the airplane.

## WEIGHT AND BALANCE

Often a pilot regards the airplane’s weight and balance data as information of interest only to engineers, dispatchers, and operators of scheduled and non-scheduled air carriers. Along with this idea, the reasoning is that the airplane was weighed during the certification process and that this data is valid indefinitely, regardless of equipment changes or modifications. Further, this information is mistakenly reduced to a workable routine or “rule of thumb” such as: “If I have three passengers, I can load only 100 gallons of fuel; four passengers—70 gallons.”



Admittedly, this rule of thumb is adequate in many cases, but as the subject “Weight and Balance” suggests, the concern is not only with the weight of the airplane but also the location of its center of gravity (CG). The importance of the CG should have become apparent in the discussion of stability, controllability, and performance. If all pilots understood and respected the effect of CG on an airplane, then one type of accident would be eliminated from the records: “PRIMARY CAUSE OF ACCIDENT—AIRPLANE CENTER OF GRAVITY OUT OF REARWARD LIMITS AND UNEQUAL LOAD DISTRIBUTION RESULTING IN AN UNSTABLE AIRPLANE. PILOT LOST CONTROL OF AIRPLANE ON TAKEOFF AND CRASHED.”

The reasons airplanes are so certificated are obvious when one gives it a little thought. For instance, it is of added value to the pilot to be able to carry extra fuel for extended flights when the full complement of passengers is not to be carried. Further, it is unreasonable to forbid the carriage of baggage when it is only during spins that its weight will adversely affect the airplane’s flight characteristics. Weight and balance limits are placed on airplanes for two principal reasons:

1. Because of the effect of the weight on the airplane’s primary structure and its performance characteristics; and
2. Because of the effect the location of this weight has on flight characteristics, particularly in stall and spin recovery and stability.

### **EFFECTS OF WEIGHT ON FLIGHT PERFORMANCE**

The takeoff/climb and landing performance of an airplane are determined on the basis of its maximum allowable takeoff and landing weights. A heavier gross weight will result in a longer takeoff run and shallower climb, and a faster touchdown speed and longer landing roll. Even a minor overload may make it impossible for the airplane to clear an obstacle that normally would not have been seriously considered during takeoffs under more favorable conditions.

The detrimental effects of overloading on performance are not limited to the immediate hazards involving takeoffs and landings. Overloading has an adverse effect on all climb and cruise performance which leads to overheating during climbs, added wear on engine parts, increased fuel consumption, slower cruising speeds, and reduced range.

The manufacturers of modern airplanes furnish weight and balance data with each airplane produced.

Generally, this information may be found in the FAA-approved Airplane Flight Manual or Pilot’s Operating Handbook (AFM/POH). With the advancements in airplane design and construction in recent years has come the development of “easy to read charts” for determining weight and balance data. Increased performance and load carrying capability of these airplanes require strict adherence to the operating limitations prescribed by the manufacturer. Deviations from the recommendations can result in structural damage or even complete failure of the airplane’s structure. Even if an airplane is loaded well within the maximum weight limitations, it is imperative that weight distribution be within the limits of center of gravity location. The preceding brief study of aerodynamics and load factors points out the reasons for this precaution. The following discussion is background information into some of the reasons why weight and balance conditions are important to the safe flight of an airplane.

The pilot is often completely unaware of the weight and balance limitations of the airplane being flown and of the reasons for these limitations. In some airplanes, it is not possible to fill all seats, baggage compartments, and fuel tanks, and still remain within approved weight or balance limits. As an example, in several popular four-place airplanes the fuel tanks may not be filled to capacity when four occupants and their baggage are carried. In a certain two-place airplane, no baggage may be carried in the compartment aft of the seats when spins are to be practiced.

### **EFFECT OF WEIGHT ON AIRPLANE STRUCTURE**

The effect of additional weight on the wing structure of an airplane is not readily apparent. Airworthiness requirements prescribe that the structure of an airplane certificated in the normal category (in which acrobatics are prohibited) must be strong enough to withstand a load factor of 3.8 to take care of dynamic loads caused by maneuvering and gusts. This means that the primary structure of the airplane can withstand a load of 3.8 times the approved gross weight of the airplane without structural failure occurring. If this is accepted as indicative of the load factors that may be imposed during operations for which the airplane is intended, a 100-pound overload imposes a potential structural overload of 380 pounds. The same consideration is even more impressive in the case of utility and acrobatic category airplanes, which have load factor requirements of 4.4 and 6.0 respectively.

Structural failures which result from overloading may be dramatic and catastrophic, but more often they affect structural components progressively in a



manner which is difficult to detect and expensive to repair. One of the most serious results of habitual overloading is that its results tend to be cumulative, and may result in structural failure later during completely normal operations. The additional stress placed on structural parts by overloading is believed to accelerate the occurrence of metallic fatigue failures.

A knowledge of load factors imposed by flight maneuvers and gusts will emphasize the consequences of an increase in the gross weight of an airplane. The structure of an airplane about to undergo a load factor of 3 G's, as in the recovery from a steep dive, must be prepared to withstand an added load of 300 pounds for each 100-pound increase in weight. It should be noted that this would be imposed by the addition of about 16 gallons of unneeded fuel in a particular airplane. The FAA certificated civil airplane has been analyzed structurally, and tested for flight at the maximum gross weight authorized and within the speeds posted for the type of flights to be performed. Flights at weights in excess of this amount are quite possible and often are well within the performance capabilities of an airplane. Nonetheless, this fact should not be allowed to mislead the pilot, as the pilot may not realize that loads for which the airplane was not designed are being imposed on all or some part of the structure.

In loading an airplane with either passengers or cargo, the structure must be considered. Seats, baggage compartments, and cabin floors are designed for a certain load or concentration of load and no more. As an example, a light plane baggage compartment may be placarded for 20 pounds because of the limited strength of its supporting structure even though the airplane may not be overloaded or out of center-of-gravity limits with more weight at that location.

### EFFECTS OF WEIGHT ON STABILITY AND CONTROLLABILITY

The effects that overloading has on stability also are not generally recognized. An airplane, which is observed to be quite stable and controllable when loaded normally, may be discovered to have very different flight characteristics when it is overloaded. Although the distribution of weight has the most direct effect on this, an increase in the airplane's gross weight may be expected to have an adverse effect on stability, regardless of location of the center of gravity.

The stability of many certificated airplanes is completely unsatisfactory if the gross weight is exceeded.

### EFFECT OF LOAD DISTRIBUTION

The effect of the position of the center of gravity on the load imposed on an airplane's wing in flight is not generally realized, although it may be very significant to climb and cruising performance. Contrary to the beliefs of some pilots, an airplane with forward loading is "heavier" and consequently, slower than the same airplane with the center of gravity further aft.

Figure 3-39 illustrates the reason for this. With forward loading, "nose-up" trim is required in most airplanes to maintain level cruising flight. Nose-up trim involves setting the tail surfaces to produce a greater down load on the aft portion of the fuselage, which adds to the wing loading and the total lift required from the wing if altitude is to be maintained. This requires a higher angle of attack of the wing, which results in more drag and, in turn, produces a higher stalling speed.

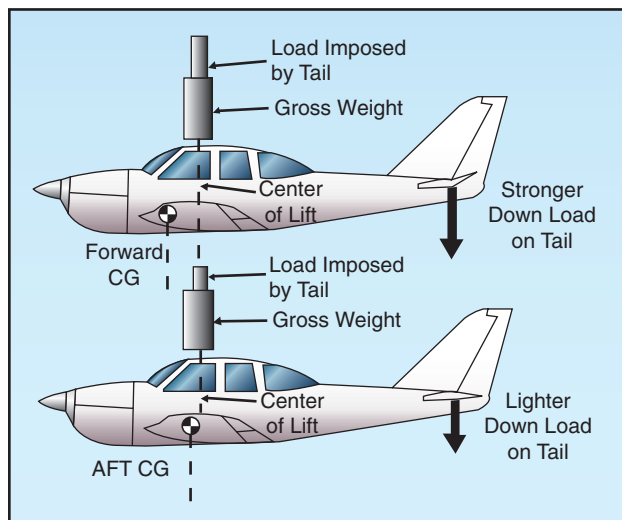

Figure 3-39. Load distribution affects balance.

With aft loading and "nose-down" trim, the tail surfaces will exert less down load, relieving the wing of that much wing loading and lift required to maintain altitude. The required angle of attack of the wing is less, so the drag is less, allowing for a faster cruise speed. Theoretically, a neutral load on the tail surfaces in cruising flight would produce the most efficient overall performance and fastest cruising speed, but would also result in instability. Consequently, modern airplanes are designed to require a down load on the tail for stability and controllability.

Remember that a zero indication on the trim tab control is not necessarily the same as "neutral trim" because of the force exerted by downwash from the wings and the fuselage on the tail surfaces.

The effects of the distribution of the airplane's useful load have a significant influence on its flight

characteristics, even when the load is within the center-of-gravity limits and the maximum permissible gross weight. Important among these effects are changes in controllability, stability, and the actual load imposed on the wing.

Generally, an airplane becomes less controllable, especially at slow flight speeds, as the center of gravity is moved further aft. An airplane which cleanly recovers from a prolonged spin with the center of gravity at one position may fail completely to respond to normal recovery attempts when the center of gravity is moved aft by 1 or 2 inches.

It is common practice for airplane designers to establish an aft center-of-gravity limit that is within 1 inch of the maximum which will allow normal recovery from a one-turn spin. When certificating an airplane in the utility category to permit intentional spins, the aft center-of-gravity limit is usually established at a point several inches forward of that which is permissible for certification in the normal category.

Another factor affecting controllability, which is becoming more important in current designs of large airplanes, is the effect of long moment arms to the positions of heavy equipment and cargo. The same airplane may be loaded to maximum gross weight within its center-of-gravity limits by concentrating fuel, passengers, and cargo near the design center of gravity; or by dispersing fuel and cargo loads in wingtip tanks and cargo bins forward and aft of the cabin.

With the same total weight and center of gravity, maneuvering the airplane or maintaining level flight in turbulent air will require the application of greater control forces when the load is dispersed. This is true because of the longer moment arms to the positions of the heavy fuel and cargo loads which must be overcome by the action of the control surfaces. An airplane with full outboard wing tanks or tip tanks tends to be sluggish in roll when control situations are marginal, while one with full nose and aft cargo bins tends to be less responsive to the elevator controls.

The rearward center-of-gravity limit of an airplane is determined largely by considerations of stability. The original airworthiness requirements for a type certificate specify that an airplane in flight at a certain speed will dampen out vertical displacement of the nose within a certain number of oscillations. An airplane loaded too far rearward may not do this; instead when the nose is momentarily pulled up, it may alternately climb and dive becoming steeper with each oscillation. This instability is not only uncomfortable to occupants, but it could even

become dangerous by making the airplane unmanageable under certain conditions.

The recovery from a stall in any airplane becomes progressively more difficult as its center of gravity moves aft. This is particularly important in spin recovery, as there is a point in rearward loading of any airplane at which a “flat” spin will develop. A flat spin is one in which centrifugal force, acting through a center of gravity located well to the rear, will pull the tail of the airplane out away from the axis of the spin, making it impossible to get the nose down and recover.

An airplane loaded to the rear limit of its permissible center-of-gravity range will handle differently in turns and stall maneuvers and have different landing characteristics than when it is loaded near the forward limit.

The forward center-of-gravity limit is determined by a number of considerations. As a safety measure, it is required that the trimming device, whether tab or adjustable stabilizer, be capable of holding the airplane in a normal glide with the power off. A conventional airplane must be capable of a full stall, power-off landing in order to ensure minimum landing speed in emergencies. A tailwheel-type airplane loaded excessively nose heavy will be difficult to taxi, particularly in high winds. It can be nosed over easily by use of the brakes, and it will be difficult to land without bouncing since it tends to pitch down on the wheels as it is slowed down and flared for landing. Steering difficulties on the ground may occur in nosewheel-type airplanes, particularly during the landing roll and takeoff.

- The CG position influences the lift and angle of attack of the wing, the amount and direction of force on the tail, and the degree of deflection of the stabilizer needed to supply the proper tail force for equilibrium. The latter is very important because of its relationship to elevator control force.
- The airplane will stall at a higher speed with a forward CG location. This is because the stalling angle of attack is reached at a higher speed due to increased wing loading.
- Higher elevator control forces normally exist with a forward CG location due to the increased stabilizer deflection required to balance the airplane.
- The airplane will cruise faster with an aft CG location because of reduced drag. The drag is reduced because a smaller angle of attack and less

downward deflection of the stabilizer are required to support the airplane and overcome the nose-down pitching tendency.

- The airplane becomes less stable as the CG is moved rearward. This is because when the CG is moved rearward it causes an increase in the angle of attack. Therefore, the wing contribution to the airplane's stability is now decreased, while the tail contribution is still stabilizing. When the point is reached that the wing and tail contributions balance, then neutral stability exists. Any CG movement further aft will result in an unstable airplane.
- A forward CG location increases the need for greater back elevator pressure. The elevator may no longer be able to oppose any increase in nose-down pitching. Adequate elevator control is needed to control the airplane throughout the airspeed range down to the stall.

## HIGH-SPEED FLIGHT

### SUPERSONIC VS. SUBSONIC FLOW

In subsonic aerodynamics, the theory of lift is based upon the forces generated on a body and a moving gas (air) in which it is immersed. At speeds below about 260 knots, air can be considered incompressible, in that at a fixed altitude, its density remains nearly constant while its pressure varies. Under this assumption, air acts the same as water and is classified as a fluid. Subsonic aerodynamic theory also assumes the effects of viscosity (the property of a fluid that tends to prevent motion of one part of the fluid with respect to another) are negligible, and classifies air as an ideal fluid, conforming to the principles of ideal-fluid aerodynamics such as continuity, Bernoulli's principle, and circulation.

In reality, air is compressible and viscous. While the effects of these properties are negligible at low speeds, compressibility effects in particular become increasingly important as speed increases. Compressibility (and to a lesser extent viscosity) is of paramount importance at speeds approaching the speed of sound. In these speed ranges, compressibility causes a change in the density of the air around an airplane.

During flight, a wing produces lift by accelerating the airflow over the upper surface. This accelerated air can, and does, reach sonic speeds even though the airplane itself may be flying subsonic. At some extreme angles of attack, in some airplanes, the speed of the air over the top surface of the wing may be double the airplane's speed. It is therefore entirely

possible to have both supersonic and subsonic airflow on an airplane at the same time. When flow velocities reach sonic speeds at some location on an airplane (such as the area of maximum camber on the wing), further acceleration will result in the onset of compressibility effects such as shock wave formation, drag increase, buffeting, stability, and control difficulties. Subsonic flow principles are invalid at all speeds above this point. [Figure 3-40]

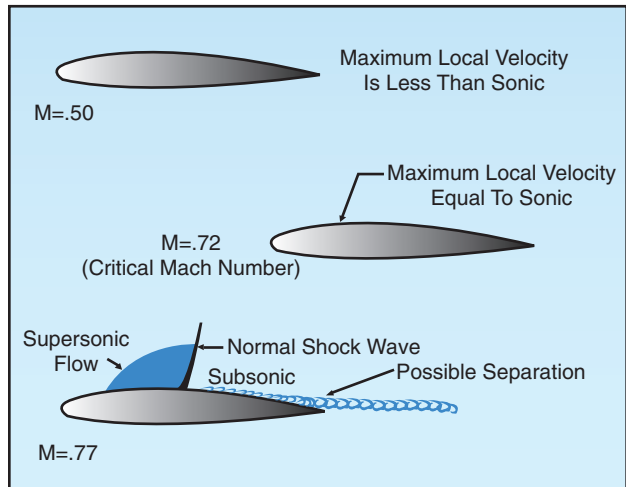

Figure 3-40. Wing airflow.

### SPEED RANGES

The speed of sound varies with temperature. Under standard temperature conditions of 15°C, the speed of sound at sea level is 661 knots. At 40,000 feet, where the temperature is -55°C, the speed of sound decreases to 574 knots. In high-speed flight and/or high-altitude flight, the measurement of speed is expressed in terms of a "Mach number"—the ratio of the true airspeed of the airplane to the speed of sound in the same atmospheric conditions. An airplane traveling at the speed of sound is traveling at Mach 1.0. Airplane speed regimes are defined as follows:

Subsonic—Mach numbers below 0.75

Transonic—Mach numbers from .075 to 1.20

Supersonic—Mach numbers from 1.20 to 5.00

Hypersonic—Mach numbers above 5.00

While flights in the transonic and supersonic ranges are common occurrences for military airplanes, civilian jet airplanes normally operate in a cruise speed range of Mach 0.78 to Mach 0.90.

The speed of an airplane in which airflow over any part of the wing first reaches (but does not exceed) Mach 1.0 is termed that airplane's critical Mach number or "Mach Crit." Thus, critical Mach number

is the boundary between subsonic and transonic flight and is an important point of reference for all compressibility effects encountered in transonic flight. Shock waves, buffet, and airflow separation take place above critical Mach number. A jet airplane typically is most efficient when cruising at or near its critical Mach number. At speeds 5 – 10 percent above the critical Mach number, compressibility effects begin. Drag begins to rise sharply. Associated with the “drag rise” are buffet, trim and stability changes, and a decrease in control surface effectiveness. This is the point of “drag divergence,” and is typically the speed chosen for high-speed cruise operations. At some point beyond high-speed cruise are the turbine powered airplane’s maximum operating limit speeds:  $V_{MO}/M_{MO}$ . [Figure 3-41]

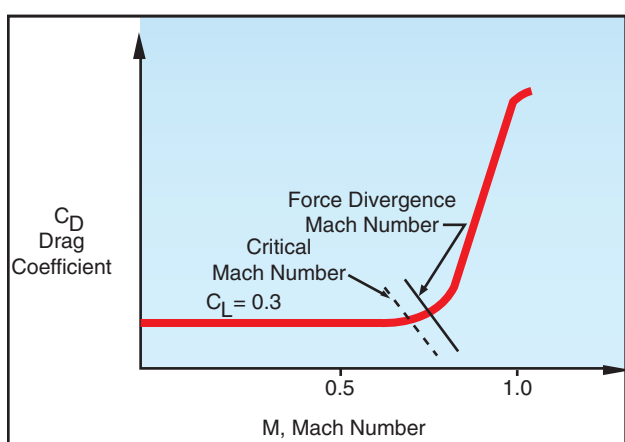

Figure 3-41. Critical Mach.

$V_{MO}$  is the maximum operating speed expressed in terms of knots.  $V_{MO}$  limits ram air pressure acting against the structure and prevents flutter.  $M_{MO}$  is the maximum operating speed expressed in terms of Mach number. An airplane should not be flown in excess of this speed. Doing so risks encountering the full effects of compressibility, including possible loss of control.

### MACH NUMBER VS. AIRSPEED

Speeds such as Mach Crit and  $M_{MO}$  for a specific airplane occur at a given Mach number. The true airspeed (TAS), however, varies with outside air temperature. Therefore, true airspeeds corresponding to a specific Mach number can vary considerably (as much as 75 – 100 knots). When an airplane cruising at a constant Mach number enters an area of higher outside air temperatures, true airspeed and required fuel increases, and range decreases. Conversely, when entering an area of colder outside air temperatures, true airspeed and fuel flow decreases, and range increases.

In a jet airplane operating at high altitude, the indicated airspeed (IAS) for any given Mach number decreases with an increase in altitude above a certain level. The reverse occurs during descent. Normally, climbs and

descents are accomplished using indicated airspeed in the lower altitudes and Mach number in the higher altitudes.

Unlike operations in the lower altitudes, the indicated airspeed (IAS) at which a jet airplane stalls increases significantly with altitude. This is due to the fact that true airspeed (TAS) increases with altitude. At high true airspeeds, air compression causes airflow distortion over the wings and in the pitot system. At the same time, the indicated airspeed (IAS) representing  $M_{MO}$  decreases with altitude. Eventually, the airplane can reach an altitude where there is little or no difference between the two.

### BOUNDARY LAYER

Air has viscosity, and will encounter resistance to flow over a surface. The viscous nature of airflow reduces the local velocities on a surface and is responsible for skin friction drag. As the air passes over the wing’s surface, the air particles nearest the surface come to rest. The next layer of particles is slowed down but not stopped. Some small but measurable distance from the surface, the air particles are moving at free stream velocity. The layer of air over the wing’s surface, which is slowed down or stopped by viscosity, is termed the “boundary layer.” Typical boundary layer thicknesses on an airplane range from small fractions of an inch near the leading edge of a wing to the order of 12 inches at the aft end of a large airplane such as a Boeing 747.

There are two different types of boundary layer flow: laminar and turbulent. The laminar boundary layer is a very smooth flow, while the turbulent boundary layer contains swirls or “eddies.” The laminar flow creates less skin friction drag than the turbulent flow, but is less stable. Boundary layer flow over a wing surface begins as a smooth laminar flow. As the flow continues back from the leading edge, the laminar boundary layer increases in thickness. At some distance back from the leading edge, the smooth laminar flow breaks down and transitions to a turbulent flow. From a drag standpoint, it is advisable to have the transition from laminar to turbulent flow as far aft on the wing as possible, or have a large amount of the wing surface within the laminar portion of the boundary layer. The low energy laminar flow, however, tends to break down more suddenly than the turbulent layer.

Another phenomenon associated with viscous flow is separation. Separation occurs when the airflow breaks away from an airfoil. The natural progression is from laminar boundary layer to turbulent boundary layer and then to airflow separation. Airflow separation produces high drag and ultimately destroys lift. The boundary layer separation point



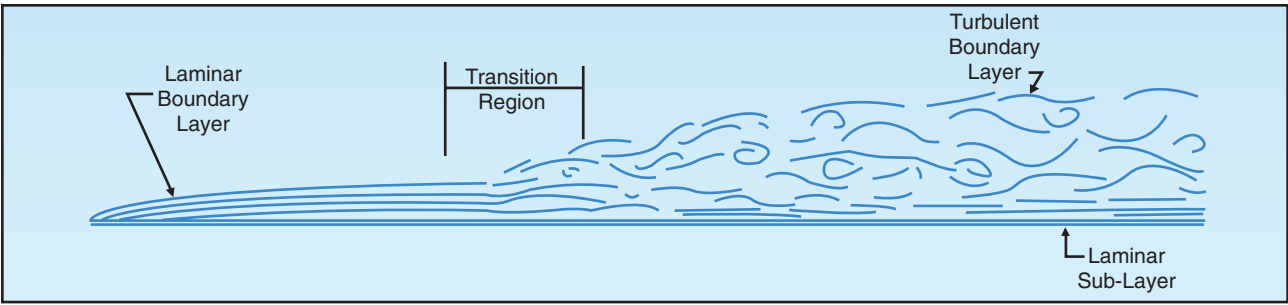

Figure 3-42. Boundary layer.

moves forward on the wing as the angle of attack is increased. [Figure 3-42]

“Vortex Generators” are used to delay or prevent shock wave induced boundary layer separation encountered in transonic flight. Vortex generators are small low aspect ratio airfoils placed at a  $12^\circ$  to  $15^\circ$  angle of attack to the airstream. They are usually spaced a few inches apart along the wing ahead of the ailerons or other control surfaces. Vortex generators create a vortex which mixes the boundary airflow with the high energy airflow just above the surface. This produces higher surface velocities and increases the energy of the boundary layer. Thus, a stronger shock wave will be necessary to produce airflow separation.

### SHOCK WAVES

When an airplane flies at subsonic speeds, the air ahead is “warned” of the airplane’s coming by a pressure change transmitted ahead of the airplane at the speed of sound. Because of this warning, the air begins to move aside before the airplane arrives and is prepared to let it pass easily. When the airplane’s speed reaches the speed of sound, the pressure change can no longer warn the air ahead because the airplane is keeping up with its own pressure waves. Rather, the air particles pile up in front of the airplane causing a sharp decrease in the flow velocity directly in front of the airplane with a corresponding increase in air pressure and density.

As the airplane’s speed increases beyond the speed of sound, the pressure and density of the compressed air ahead of it increase, the area of compression extending some distance ahead of the airplane. At some point in the airstream, the air particles are completely undisturbed, having had no advanced warning of the airplane’s approach, and in the next instant the same air particles are forced to undergo sudden and drastic changes in temperature, pressure, density, and velocity. The boundary between the undisturbed air and the region of compressed air is called a shock or “compression” wave.

This same type of wave is formed whenever a supersonic airstream is slowed to subsonic without a change

in direction, such as when the airstream is accelerated to sonic speed over the cambered portion of a wing, and then decelerates to subsonic speed as the area of maximum camber is passed. A shock wave will form as a boundary between the supersonic and subsonic ranges.

Whenever a shock wave forms perpendicular to the airflow, it is termed a “normal” shock wave, and the flow immediately behind the wave is subsonic. A supersonic airstream passing through a normal shock wave will experience these changes:

- The airstream is slowed to subsonic.
- The airflow immediately behind the shock wave does not change direction.
- The static pressure and density of the airstream behind the wave is greatly increased.
- The energy of the airstream (indicated by total pressure—dynamic plus static) is greatly reduced.

Shock wave formation causes an increase in drag. One of the principal effects of a shock wave is the formation of a dense high pressure region immediately behind the wave. The instability of the high pressure region, and the fact that part of the velocity energy of the airstream is converted to heat as it flows through the wave is a contributing factor in the drag increase, but the drag resulting from airflow separation is much greater. If the shock wave is strong, the boundary layer may not have sufficient kinetic energy to withstand airflow separation. The drag incurred in the transonic region due to shock wave formation and airflow separation is known as “wave drag.” When speed exceeds the critical Mach number by about 10 percent, wave drag increases sharply. A considerable increase in thrust (power) is required to increase flight speed beyond this point into the supersonic range where, depending on the airfoil shape and the angle of attack, the boundary layer may reattach.

Normal shock waves form on the wing’s upper surface first. Further increases in Mach number, however, can enlarge the supersonic area on the

upper surface and form an additional area of supersonic flow and a normal shock wave on the lower surface. As flight speed approaches the speed of sound, the areas of supersonic flow enlarge and the shock waves move nearer the trailing edge. [Figure 3-43]

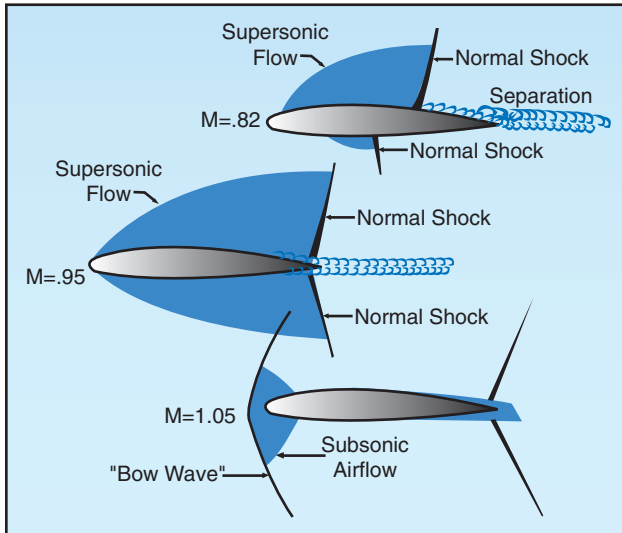

Figure 3-43. Shock waves.

Associated with “drag rise” are buffet (known as Mach buffet), trim and stability changes, and a decrease in control force effectiveness. The loss of lift due to airflow separation results in a loss of downwash, and a change in the position of the center pressure on the wing. Airflow separation produces a turbulent wake behind the wing which causes the tail surfaces to buffet (vibrate). The nose-up and nose-down pitch control provided by the horizontal tail is dependent on the downwash behind the wing. Thus, a decrease in downwash decreases the horizontal tail’s pitch control effectiveness. Movement of the wing center of pressure affects the wing pitching moment. If the center of pressure moves aft, a diving moment referred to as “Mach tuck” or “tuck under” is produced, and if it moves forward, a nose-up moment is produced. This is the primary reason for the development of

the T-tail configuration on many turbine-powered airplanes, which places the horizontal stabilizer as far as practical from the turbulence of the wings.

### SWEEPBACK

Most of the difficulties of transonic flight are associated with shock wave induced flow separation. Therefore, any means of delaying or alleviating the shock induced separation will improve aerodynamic performance. One method is wing sweepback. Sweepback theory is based upon the concept that it is only the component of the airflow perpendicular to the leading edge of the wing that affects pressure distribution and formation of shock waves. [Figure 3-44]

On a straight wing airplane, the airflow strikes the wing leading edge at  $90^\circ$ , and its full impact produces pressure and lift. A wing with sweepback is struck by the same airflow at an angle smaller than  $90^\circ$ . This airflow on the swept wing has the effect of persuading the wing into believing that it is flying slower than it really is; thus the formation of shock waves is delayed. Advantages of wing sweep include an increase in critical Mach number, force divergence

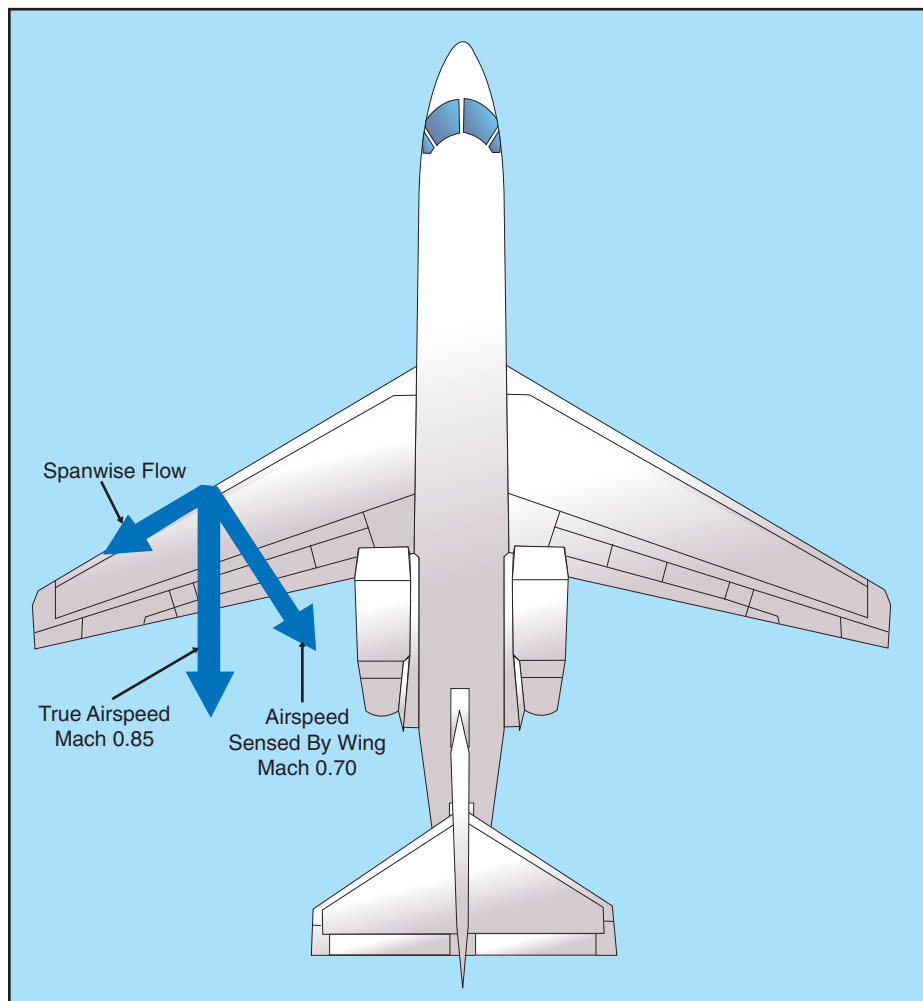

Figure 3-44. Sweepback effect.

Mach number, and the Mach number at which drag rise will peak. In other words, sweep will delay the onset of compressibility effects.

The Mach number, which produces a sharp change in drag coefficient, is termed the “force divergence” Mach number and, for most airfoils, usually exceeds the critical Mach number by 5 to 10 percent. At this speed, the airflow separation induced by shock wave formation can create significant variations in the drag, lift, or pitching moment coefficients. In addition to the delay of the onset of compressibility effects, sweepback reduces the magnitude in the changes of drag, lift or moment coefficients. In other words, the use of sweepback will “soften” the force divergence.

A disadvantage of swept wings is that they tend to stall at the wingtips rather than at the wing roots. [Figure 3-45] This is because the boundary layer tends to flow spanwise toward the tips and to separate near the leading edges. Because the tips of a swept wing are on the aft part of the wing (behind the center of lift), a wingtip stall will cause the center of lift to move forward on the wing, forcing the nose to rise further. The tendency for tip stall is greatest when wing sweep and taper are combined.

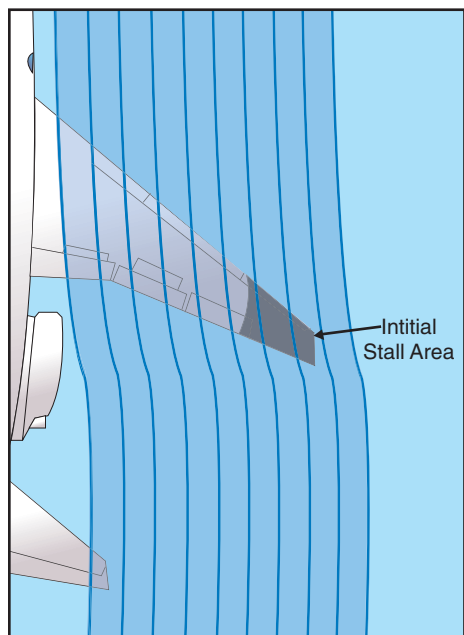

Figure 3-45 Wingtip stall.

The stall situation can be aggravated by a T-tail configuration, which affords little or no pre-stall warning in the form of tail control surface buffet. [Figure 3-46] The T-tail, being above the wing wake remains effective even after the wing has begun to stall, allowing the pilot to inadvertently drive the wing into a deeper stall at a much greater angle of attack. If the horizontal tail surfaces then become buried in the

wing’s wake, the elevator may lose all effectiveness, making it impossible to reduce pitch attitude and break the stall. In the pre-stall and immediate post-stall regimes, the lift/drag qualities of a swept wing airplane (specifically the enormous increase in drag at low speeds) can cause an increasingly descending flight-path with no change in pitch attitude, further increasing the angle of attack. In this situation, without reliable angle of attack information, a nose-down pitch attitude with an increasing airspeed is no guarantee that recovery has been effected, and up-elevator movement at this stage may merely keep the airplane stalled.

It is a characteristic of T-tail airplanes to pitch up viciously when stalled in extreme nose-high attitudes, making recovery difficult or violent. The stick pusher inhibits this type of stall. At approximately one knot above stall speed, pre-programmed stick forces automatically move the stick forward, preventing the stall from developing. A “g” limiter may also be incorporated into the system to prevent the pitch down generated by the stick pusher from imposing excessive loads on the airplane. A “stick

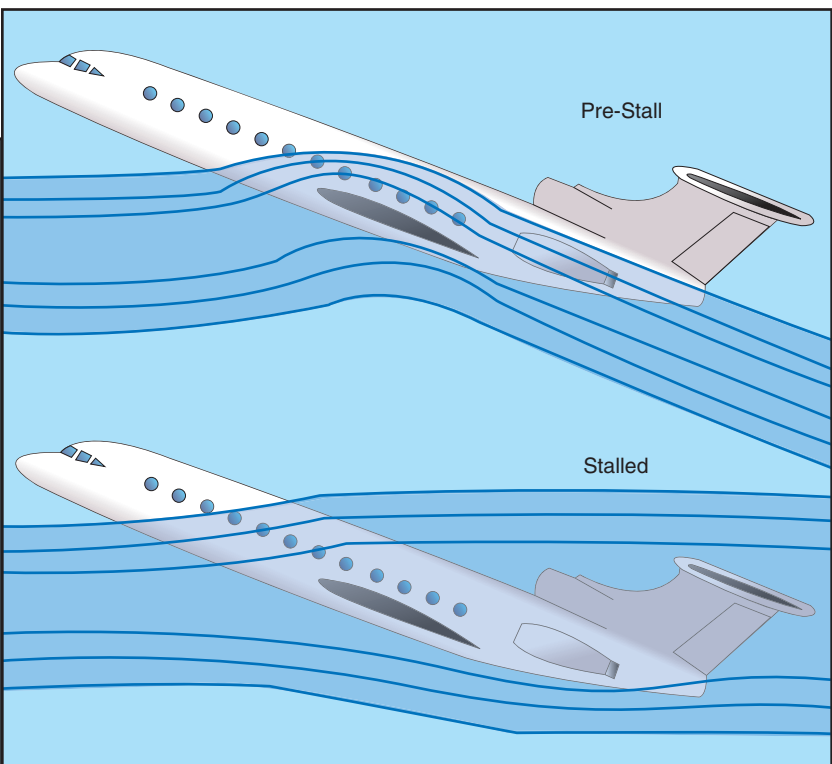

Figure 3-46. T-tail stall.

shaker,” on the other hand provides stall warning when the airspeed is 5 to 7 percent above stall speed.

### MACH BUFFET BOUNDARIES

Thus far, only the Mach buffet that results from excessive speed has been addressed. It must be remembered that Mach buffet is a function of the speed of the airflow over the wing—not necessarily the speed of the airplane. Any time that too great a

lift demand is made on the wing, whether from too fast an airspeed or from too high an angle of attack near the  $M_{MO}$ , the “high-speed” buffet will occur. However, there are also occasions when the buffet can be experienced at much lower speeds known as the “low-speed Mach buffet.”

The most likely situation that could cause the low-speed buffet would be when the airplane is flown at too slow a speed for its weight and altitude necessitating a high angle of attack. This very high angle of attack would have the effect of increasing airflow velocity over the upper surface of the wing to the point that all of the same effects of the shock waves and buffet would occur as in the high-speed buffet situation. The angle of attack of the wing has the greatest effect on inducing the Mach buffet at either the high-speed or low-speed boundaries for the airplane. The conditions that increase the angle of attack, hence the speed of the airflow over the wing and chances of Mach buffet are as follows:

- **High Altitudes**—The higher an airplane flies, the thinner the air and the greater the angle of attack required to produce the lift needed to maintain level flight.
- **Heavy Weights**—The heavier the airplane, the greater the lift required of the wing, and all other things being equal, the greater the angle of attack.
- **“G” Loading**—An increase in the “G” loading on the airplane has the same effect as increasing the weight of the airplane. Whether the increase in “G” forces is caused by turns, rough control usage, or turbulence, the effect of increasing the wing’s angle of attack is the same.

## FLIGHT CONTROLS

On high-speed airplanes, flight controls are divided into primary flight controls and secondary or auxiliary flight controls. The primary flight controls maneuver the airplane about the pitch, roll, and yaw axes. They include the ailerons, elevator, and rudder. Secondary or auxiliary flight controls include tabs, leading edge flaps, trailing edge flaps, spoilers, and slats.

Spoilers are used on the upper surface of the wing to spoil or reduce lift. High-speed airplanes, due to their clean low drag design use spoilers as speed brakes to slow them down. Spoilers are extended immediately after touchdown to dump lift and thus transfer the weight of the airplane from the wings onto the wheels for better braking performance. [Figure 3-47]

Jet transport airplanes have small ailerons. The space for ailerons is limited because as much of the wing

trailing edge as possible is needed for flaps. Another reason is that a conventional size aileron would cause wing twist at high speed. Because the ailerons are necessarily small, spoilers are used in unison with ailerons to provide additional roll control.

Some jet transports have two sets of ailerons; a pair of outboard low-speed ailerons, and a pair of high-speed inboard ailerons. When the flaps are fully retracted after takeoff, the outboard ailerons are automatically locked out in the faired position.

When used for roll control, the spoiler on the side of the up-going aileron extends and reduces the lift on that side, causing the wing to drop. If the spoilers are extended as speed brakes, they can still be used for roll control. If they are the Differential type, they will extend further on one side and retract on the other side. If they are the Non-Differential type, they will extend further on one side but will not retract on the other side. When fully extended as speed brakes, the Non-Differential spoilers remain extended and do not supplement the ailerons.

To obtain a smooth stall and a higher angle of attack without airflow separation, an airplane’s wing leading edge should have a well-rounded almost blunt shape that the airflow can adhere to at the higher angle of attack. With this shape, the airflow separation will start at the trailing edge and progress forward gradually as angle of attack is increased.

The pointed leading edge necessary for high-speed flight results in an abrupt stall and restricts the use of trailing edge flaps because the airflow cannot follow the sharp curve around the wing leading edge. The airflow tends to tear loose rather suddenly from the upper surface at a moderate angle of attack. To utilize trailing edge flaps, and thus increase the maximum lift coefficient, the wing must go to a higher angle of attack without airflow separation. Therefore, leading edge slots, slats, and flaps are used to improve the low-speed characteristics during takeoff, climb, and landing. Although these devices are not as powerful as trailing edge flaps, they are effective when used full span in combination with high-lift trailing edge flaps. With the aid of these sophisticated high-lift devices, airflow separation is delayed and the maximum lift coefficient ( $C_{Lmax}$ ) is increased considerably. In fact, a 50-knot reduction in stall speed is not uncommon.

The operational requirements of a large jet transport airplane necessitate large pitch trim changes. Some of these requirements are:

- The requirement for a large CG range.
- The need to cover a large speed range.



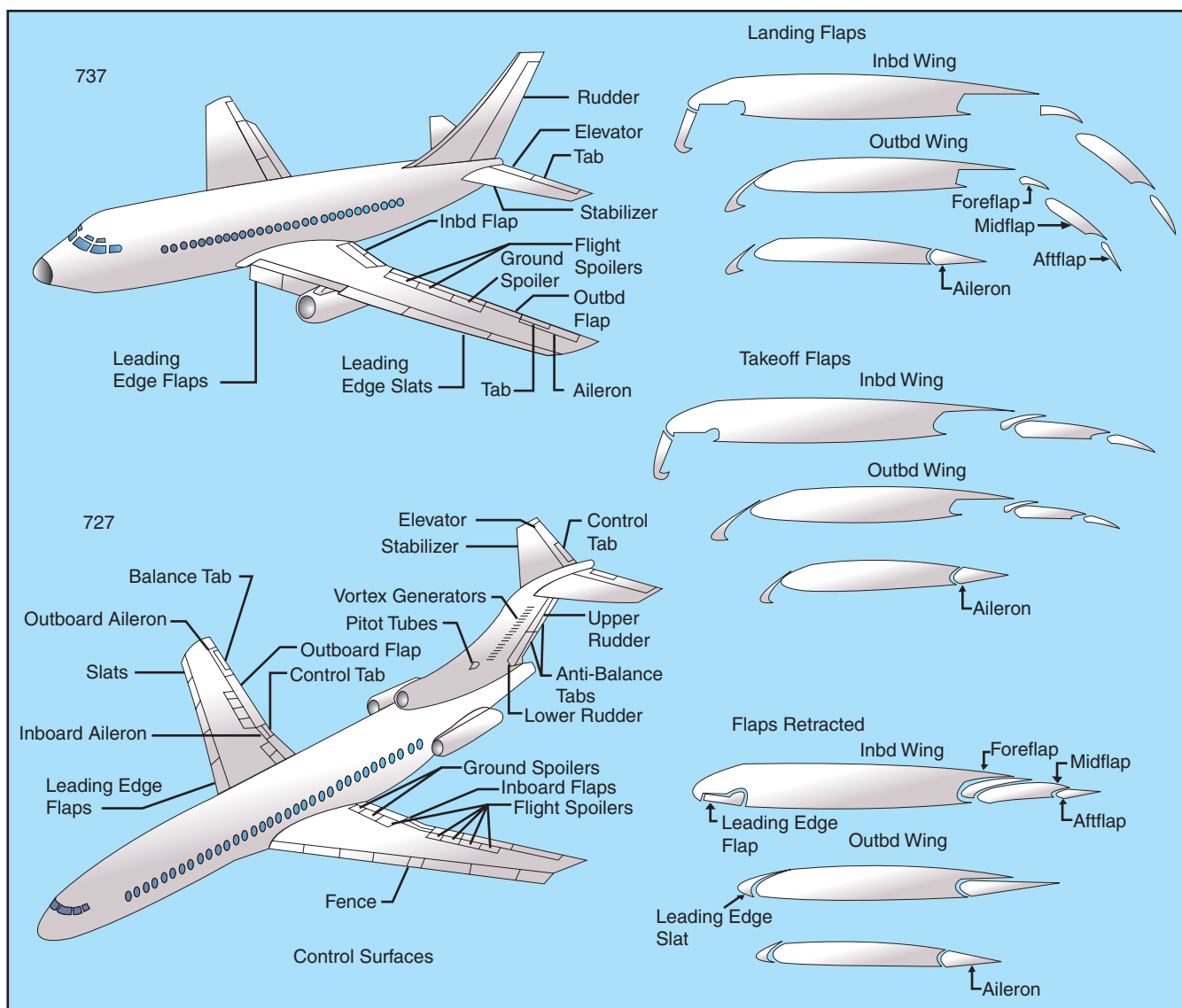

Figure 3-47. Control surfaces.

- The need to cope with possibly large trim changes due to wing leading edge and trailing edge high-lift devices without limiting the amount of elevator remaining.
- The need to reduce trim drag to a minimum.

These requirements are met by the use of a variable incidence horizontal stabilizer. Large trim changes on a fixed-tail airplane require large elevator deflections. At these large deflections, little further elevator movement remains in the same direction. A variable incidence horizontal stabilizer is designed to take out the trim changes. The stabilizer is larger than the elevator, and consequently does not need to be moved through as large an angle. This leaves the elevator streamlining the tail plane with a full range of movement up and down. The variable incidence horizontal stabilizer can be set to handle the bulk of the pitch control demand, with the elevator handling the rest. On airplanes equipped with a variable

incidence horizontal stabilizer, the elevator is smaller and less effective in isolation than it is on a fixed-tail airplane. In comparison to other flight controls, the variable incidence horizontal stabilizer is enormously powerful in its effect. Its use and effect must be fully understood and appreciated by flight crewmembers.

Because of the size and high speeds of jet transport airplanes, the forces required to move the control surfaces can be beyond the strength of the pilot. Consequently, the control surfaces are actuated by hydraulic or electrical power units. Moving the controls in the cockpit signals the control angle required, and the power unit positions the actual control surface. In the event of complete power unit failure, movement of the control surface can be effected by manually controlling the control tabs. Moving the control tab upsets the aerodynamic balance which causes the control surface to move.

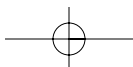
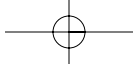

# Chapter 4

## Flight Controls



Aircraft flight control systems are classified as primary and secondary. The primary control systems consist of those that are required to safely control an airplane during flight. These include the ailerons, elevator (or stabilator), and rudder. Secondary control systems improve the performance characteristics of the airplane, or relieve the pilot of excessive control forces. Examples of secondary control systems are wing flaps and trim systems.

### PRIMARY FLIGHT CONTROLS

Airplane control systems are carefully designed to provide a natural feel, and at the same time, allow adequate responsiveness to control inputs. At low airspeeds, the controls usually feel soft and sluggish, and the airplane responds slowly to control applications. At high speeds, the controls feel firm and the response is more rapid.

Movement of any of the three primary flight control surfaces changes the airflow and pressure distribution over and around the airfoil. These changes affect the lift and drag produced by the airfoil/control surface combination, and allow a pilot to control the airplane about its three axes of rotation.

Design features limit the amount of deflection of flight control surfaces. For example, control-stop mechanisms may be incorporated into the flight controls, or movement of the control column and/or rudder pedals may be limited. The purpose of these design limits is to prevent the pilot from inadvertently overcontrolling and overstressing the aircraft during normal maneuvers.

A properly designed airplane should be stable and easily controlled during maneuvering. Control surface inputs cause movement about the three axes of rotation. The types of stability an airplane exhibits also relate to the three axes of rotation. [Figure 4-1]

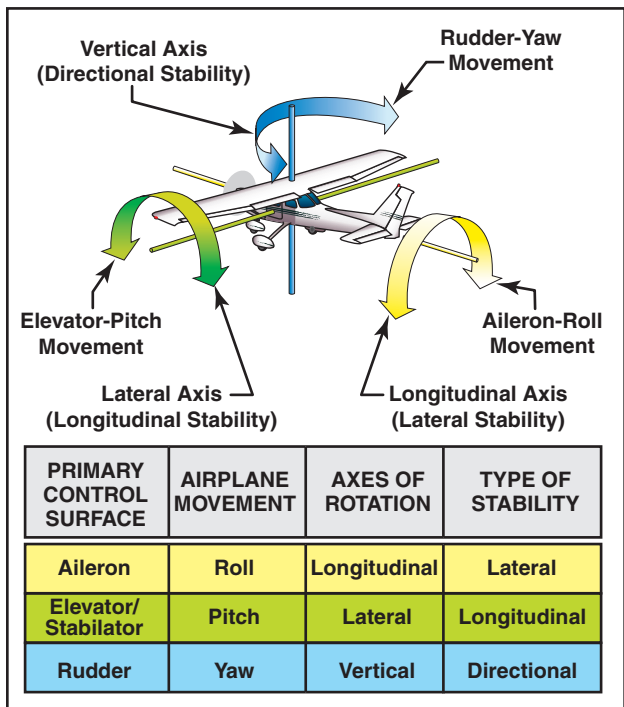

Figure 4-1. Airplane controls, movement, axes of rotation, and type of stability.

### AILERONS

Ailerons control roll about the longitudinal axis. The ailerons are attached to the outboard trailing edge of

each wing and move in the opposite direction from each other. Ailerons are connected by cables, bellcranks, pulleys or push-pull tubes to each other and to the control wheel.

Moving the control wheel to the right causes the right aileron to deflect upward and the left aileron to deflect downward. The upward deflection of the right aileron decreases the camber resulting in decreased lift on the right wing. The corresponding downward deflection of the left aileron increases the camber resulting in increased lift on the left wing. Thus, the increased lift on the left wing and the decreased lift on the right wing causes the airplane to roll to the right.

### ADVERSE YAW

Since the downward deflected aileron produces more lift, it also produces more drag. This added drag attempts to yaw the airplane's nose in the direction of the raised wing. This is called adverse yaw. [Figure 4-2]

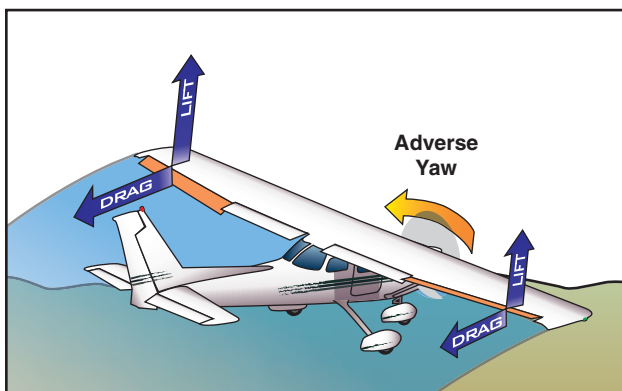

Figure 4-2. Adverse yaw is caused by higher drag on the outside wing, which is producing more lift.

The rudder is used to counteract adverse yaw, and the amount of rudder control required is greatest at low airspeeds, high angles of attack, and with large aileron deflections. However, with lower airspeeds, the vertical stabilizer/rudder combination becomes less effective, and magnifies the control problems associated with adverse yaw.

All turns are coordinated by use of ailerons, rudder, and elevator. Applying aileron pressure is necessary to place the airplane in the desired angle of bank, while simultaneously applying rudder pressure to counteract the resultant adverse yaw. During a turn, the angle of attack must be increased by applying elevator pressure because more lift is required than when in straight-and-level flight. The steeper the turn, the more back elevator pressure is needed.

As the desired angle of bank is established, aileron and rudder pressures should be relaxed. This will stop the bank from increasing because the aileron and rudder control surfaces will be neutral in their streamlined position. Elevator pressure should be held constant to maintain a constant altitude.

The rollout from a turn is similar to the roll-in except the flight controls are applied in the opposite direction. Aileron and rudder are applied in the direction of the rollout or toward the high wing. As the angle of bank decreases, the elevator pressure should be relaxed as necessary to maintain altitude.

### DIFFERENTIAL AILERONS

With differential ailerons, one aileron is raised a greater distance than the other aileron is lowered for a given movement of the control wheel. This produces an increase in drag on the descending wing. The greater drag results from deflecting the up aileron on the descending wing to a greater angle than the down aileron on the rising wing. While adverse yaw is reduced, it is not eliminated completely. [Figure 4-3]

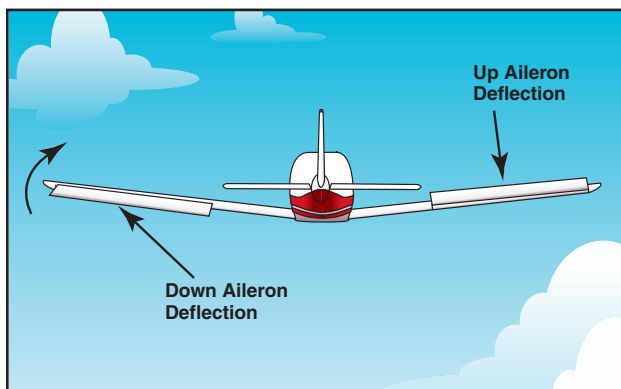

Figure 4-3. Differential ailerons.

### FRISE-TYPE AILERONS

With a Frise-type aileron, when pressure is applied to the control wheel, the aileron that is being raised pivots on an offset hinge. This projects the leading edge of the aileron into the airflow and creates drag. This helps equalize the drag created by the lowered aileron on the opposite wing and reduces adverse yaw. [Figure 4-4]

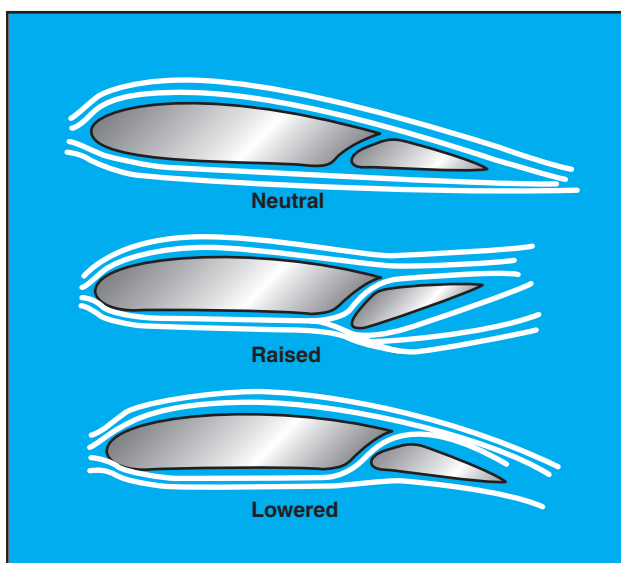

Figure 4-4. Frise-type ailerons.



The Frise-type aileron also forms a slot so that air flows smoothly over the lowered aileron, making it more effective at high angles of attack. Frise-type ailerons also may be designed to function differentially. Like the differential aileron, the Frise-type aileron does not eliminate adverse yaw entirely. Coordinated rudder application is still needed wherever ailerons are applied.

#### COUPLED AILERONS AND RUDDER

Coupled ailerons and rudder means these controls are linked. This is accomplished with rudder-aileron interconnect springs, which help correct for aileron drag by automatically deflecting the rudder at the same time the ailerons are deflected. For example, when the control yoke is moved to produce a left roll, the interconnect cable and spring pulls forward on the left rudder pedal just enough to prevent the nose of the airplane from yawing to the right. The force applied to the rudder by the springs can be overridden if it becomes necessary to slip the airplane. [Figure 4-5]

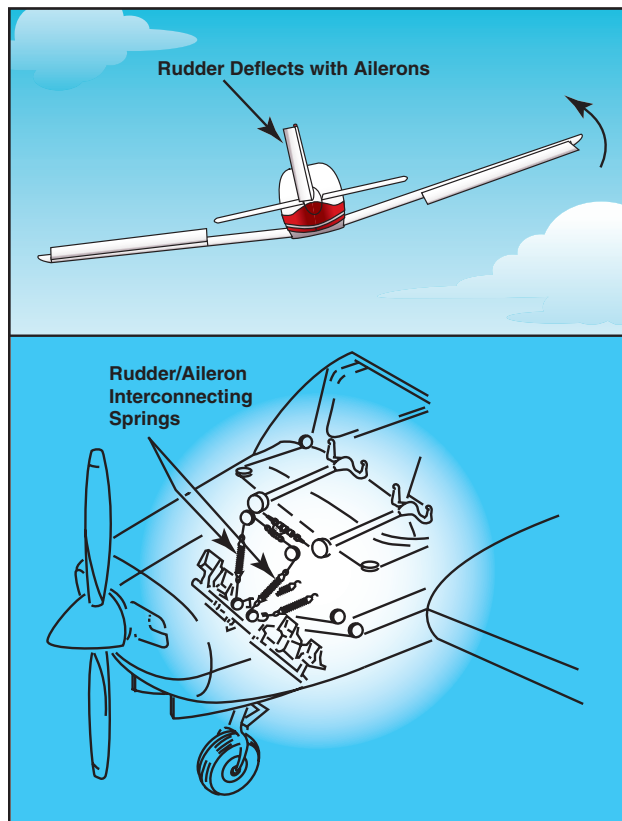

Figure 4-5. Coupled ailerons and rudder.

#### ELEVATOR

The elevator controls pitch about the lateral axis. Like the ailerons on small airplanes, the elevator is connected to the control column in the cockpit by a series of mechanical linkages. Aft movement of the control column deflects the trailing edge of the elevator surface up. This is usually referred to as up elevator. [Figure 4-6]

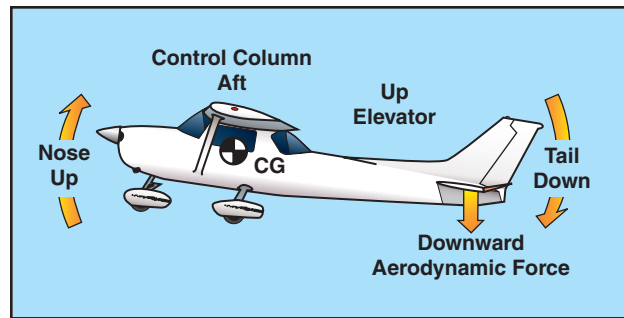

Figure 4-6. The elevator is the primary control for changing the pitch attitude of an airplane.

The up-elevator position decreases the camber of the elevator and creates a downward aerodynamic force, which is greater than the normal tail-down force that exists in straight-and-level flight. The overall effect causes the tail of the airplane to move down and the nose to pitch up. The pitching moment occurs about the center of gravity (CG). The strength of the pitching moment is determined by the distance between the CG and the horizontal tail surface, as well as by the aerodynamic effectiveness of the horizontal tail surface.

Moving the control column forward has the opposite effect. In this case, elevator camber increases, creating more lift (less tail-down force) on the horizontal stabilizer/elevator. This moves the tail upward and pitches the nose down. Again, the pitching moment occurs about the CG.

As mentioned earlier in the coverage on stability, power, thrustline, and the position of the horizontal tail surfaces on the empennage are factors in how effective the elevator is in controlling pitch. For example, the horizontal tail surfaces may be attached near the lower part of the vertical stabilizer, at the midpoint, or at the high point, as in the T-tail design.

#### T-TAIL

In a T-tail configuration, the elevator is above most of the effects of downwash from the propeller as well as airflow around the fuselage and/or wings during normal flight conditions. Operation of the elevators in this undisturbed air makes for control movements that are consistent throughout most flight regimes. T-tail designs have become popular on many light airplanes and on large aircraft, especially those with aft-fuselage mounted engines since the T-tail configuration removes the tail from the exhaust blast of the engines. Seaplanes and amphibians often have T-tails in order to keep the horizontal surfaces as far from the water as possible. An additional benefit is reduced vibration and noise inside the aircraft.

At slow speeds, the elevator on a T-tail aircraft must be moved through a larger number of degrees of travel to raise the nose a given amount as compared to a conventional-tail aircraft. This is because the

conventional-tail aircraft has the downwash from the propeller pushing down on the tail to assist in raising the nose. Since controls on aircraft are rigged in such a manner as to require increasing control forces for increased control travel, the forces required to raise the nose of a T-tail aircraft are greater than for a conventional-tail aircraft. Longitudinal stability of a trimmed aircraft is the same for both types of configuration, but the pilot must be aware that at slow speeds during takeoffs and landings or stalls, the control forces will be greater than for similar size airplanes equipped with conventional tails.

T-tail airplanes also require additional design considerations to counter the problem of flutter. Since the weight of the horizontal surfaces is at the top of the vertical stabilizer, the moment arm created causes high loads on the vertical stabilizer which can result in flutter. Engineers must compensate for this by increasing the design stiffness of the vertical stabilizer, usually resulting in a weight penalty over conventional tail designs.

When flying at a very high angle of attack with a low airspeed and an aft CG, the T-tail airplane may be susceptible to a deep stall. In a deep stall, the airflow over the horizontal tail is blanketed by the disturbed airflow from the wings and fuselage. In these circumstances, elevator or stabilator control could be diminished, making it difficult to recover from the stall. It should be noted that an aft CG could be a contributing factor in these incidents since similar recovery problems are also found with conventional-tail aircraft with an aft CG. [Figure 4-7]

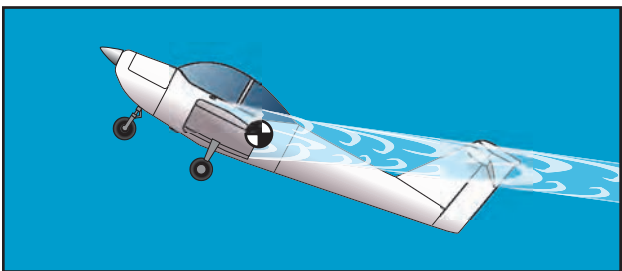
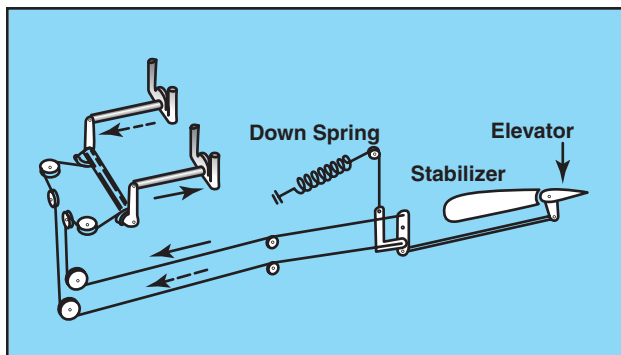

**Figure 4-7.** Airplane with a T-tail design at a high angle of attack and an aft CG.

Since flight at a high angle of attack with a low airspeed and an aft CG position can be dangerous, many airplanes have systems to compensate for this situation. The systems range from control stops to elevator down springs. An elevator down spring assists in lowering the nose to prevent a stall caused by the aft CG position. The stall occurs because the properly trimmed airplane is flying with the elevator in a trailing edge down position, forcing the tail up and the nose down. In this unstable condition, if the airplane encounters turbulence and slows down further, the trim

tab no longer positions the elevator in the nose-down position. The elevator then streamlines, and the nose of the aircraft pitches upward. This aggravates the situation and can possibly result in a stall.

The elevator down spring produces a mechanical load on the elevator, causing it to move toward the nose-down position if not otherwise balanced. The elevator trim tab balances the elevator down spring to position the elevator in a trimmed position. When the trim tab becomes ineffective, the down spring drives the elevator to a nose down position. The nose of the aircraft lowers, speed builds up, and a stall is prevented. [Figure 4-8]



**Figure 4-8.** When the aerodynamic efficiency of the horizontal tail surface is inadequate due to an aft center of gravity condition, an elevator down spring may be used to supply a mechanical load to lower the nose.

The elevator must also have sufficient authority to hold the nose of the airplane up during the roundout for a landing. In this case, a forward CG may cause a problem. During the landing flare, power normally is reduced, which decreases the airflow over the empennage. This, coupled with the reduced landing speed, makes the elevator less effective.

From this discussion, it should be apparent that pilots must understand and follow proper loading procedures, particularly with regard to the CG position. More information on aircraft loading, as well as weight and balance, is included in Chapter 8.

## STABILATOR

As mentioned in Chapter 1, a stabilator is essentially a one-piece horizontal stabilizer with the same type of control system. Because stabilators pivot around a central hinge point, they are extremely sensitive to control inputs and aerodynamic loads.

Antiservo tabs are incorporated on the trailing edge to decrease sensitivity. In addition, a balance weight is usually incorporated ahead of the main spar. The balance weight may project into the empennage or may be incorporated on the forward portion of the stabilator tips. [Figure 4-9]

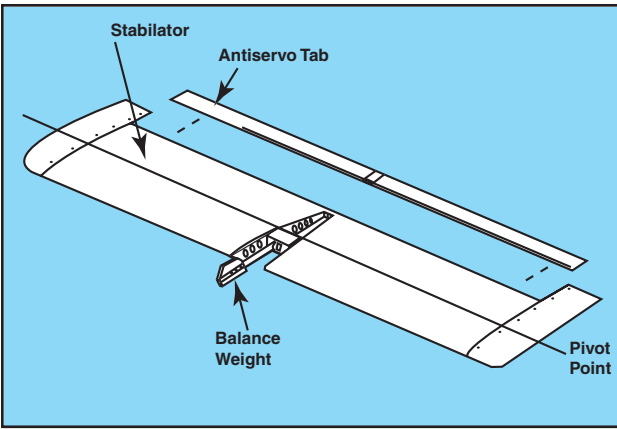

**Figure 4-9.** The stabilator is a one-piece horizontal tail surface that pivots up and down about a central hinge point.

When the control column is pulled back, it raises the stabilator's trailing edge, rotating the airplane's nose up. Pushing the control column forward lowers the trailing edge of the stabilator and pitches the nose of the airplane down. Without an antiservo tab, the airplane would be prone to overcontrolling from pilot-induced control inputs.

## CANARD

The term **canard** refers to a control surface that functions as a horizontal stabilizer but is located in front of the main wings. The term also is used to describe an airplane equipped with a canard. In effect, it is an airfoil similar to the horizontal surface on a conventional aft-tail design. The difference is that the canard actually creates lift and holds the nose up, as opposed to the aft-tail design which exerts downward force on the tail to prevent the nose from rotating downward. [Figure 4-10]



**Figure 4-10.** This advanced aircraft includes a variable-sweep canard design, which provides longitudinal stability about the lateral axis.

**Canard**—A horizontal surface mounted ahead of the main wing to provide longitudinal stability and control. It may be a fixed, movable, or variable geometry surface, with or without control surfaces.

**Canard Configuration**—A configuration in which the span of the forward wings is substantially less than that of the main wing.

Although the Wright Flyer was configured as a canard with the horizontal surfaces in front of the lifting surface, it was not until recently that the **canard configuration** began appearing on newer airplanes. Canard designs include two types—one with a horizontal surface of about the same size as a normal aft-tail design, and the other with a surface of the same approximate size and airfoil of the aft-mounted wing known as a tandem wing configuration. Theoretically, the canard is considered more efficient because using the horizontal surface to help lift the weight of the aircraft should result in less drag for a given amount of lift.

The canard's main advantage is in the area of stall characteristics. A properly designed canard or tandem wing will run out of authority to raise the nose of the aircraft at a point before the main wing will stall. This makes the aircraft stall-proof and results only in a descent rate that can be halted by adding power. Ailerons on the main wing remain effective throughout the recovery. Other canard configurations are designed so the canard stalls before the main wing, automatically lowering the nose and recovering the aircraft to a safe flying speed. Again, the ailerons remain effective throughout the stall.

The canard design has several limitations. First, it is important that the forward lifting surface of a canard design stalls before the main wing. If the main wing stalls first, the lift remaining from the forward wing or canard would be well ahead of the CG, and the airplane would pitch up uncontrollably. Second, when the forward surface stalls first, or is limited in its ability to increase the angle of attack, the main wing never reaches a point where its maximum lift is created, sacrificing some performance. Third, use of flaps on the main wing causes design problems for the forward wing or canard. As lift on the main wing is increased by extension of flaps, the lift requirement of the canard is also increased. The forward wing or canard must be large enough to accommodate flap use, but not so large that it creates more lift than the main wing.

Finally, the relationship of the main wing to the forward surface also makes a difference. When positioned closely in the vertical plane, downwash from the forward wing can have a negative effect on the lift of the main wing. Increasing vertical separation increases efficiency of the design. Efficiency is also increased as the size of the two surfaces grows closer to being equal.

## RUDDER

The rudder controls movement of the airplane about its vertical axis. This motion is called yaw. Like the

other primary control surfaces, the rudder is a movable surface hinged to a fixed surface, in this case, to the vertical stabilizer, or fin. Moving the left or right rudder pedal controls the rudder. When the rudder is deflected into the airflow, a horizontal force is exerted in the opposite direction. [Figure 4-11]

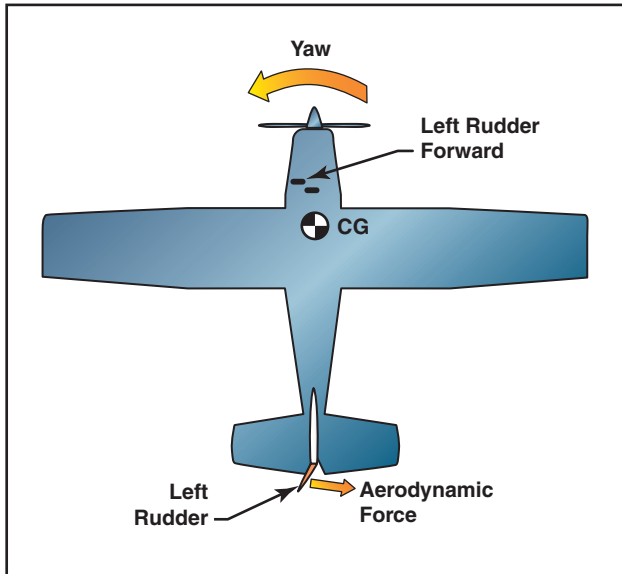

Figure 4-11. The effect of left rudder pressure.

By pushing the left pedal, the rudder moves left. This alters the airflow around the vertical stabilizer/rudder, and creates a sideward lift that moves the tail to the right and yaws the nose of the airplane to the left. Rudder effectiveness increases with speed, so large deflections at low speeds and small deflections at high speeds may be required to provide the desired reaction. In propeller-driven aircraft, any slipstream flowing over the rudder increases its effectiveness.

### V-TAIL

The V-tail design utilizes two slanted tail surfaces to perform the same functions as the surfaces of a conventional elevator and rudder configuration. The fixed surfaces act as both horizontal and vertical stabilizers. [Figure 4-12]



Figure 4-12. V-tail design.

The movable surfaces, which are usually called **ruddervators**, are connected through a special linkage that allows the control wheel to move both surfaces simultaneously. On the other hand, displacement of the rudder pedals moves the surfaces differentially, thereby providing directional control.

When both rudder and elevator controls are moved by the pilot, a control mixing mechanism moves each surface the appropriate amount. The control system for the V-tail is more complex than that required for a conventional tail. In addition, the V-tail design is more susceptible to Dutch roll tendencies than a conventional tail and total reduction in drag is only minimal.

## SECONDARY FLIGHT CONTROLS

Secondary flight control systems may consist of the flaps, leading edge devices, spoilers, and trim devices.

### FLAPS

Flaps are the most common high-lift devices used on practically all airplanes. These surfaces, which are attached to the trailing edge of the wing, increase both lift and induced drag for any given angle of attack. Flaps allow a compromise between high cruising speed and low landing speed, because they may be extended when needed, and retracted into the wing's structure when not needed. There are four common types of flaps: plain, split, slotted, and Fowler flaps. [Figure 4-13]

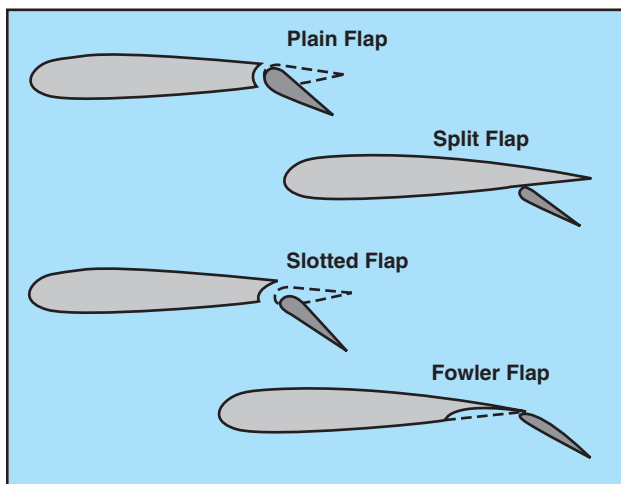

Figure 4-13. Four common types of flaps

The plain flap is the simplest of the four types. It increases the airfoil camber, resulting in a significant increase in the coefficient of lift at a given angle of attack. At the same time, it greatly increases drag and moves the center of pressure aft on the airfoil, resulting in a nose-down pitching moment.

**Ruddervator**—A pair of control surfaces on the tail of an aircraft arranged in the form of a V. These surfaces, when moved together by the control wheel, serve as elevators, and when moved differentially by the rudder pedals, serve as a rudder.



The split flap is deflected from the lower surface of the airfoil and produces a slightly greater increase in lift than does the plain flap. However, more drag is created because of the turbulent air pattern produced behind the airfoil. When fully extended, both plain and split flaps produce high drag with little additional lift.

The most popular flap on airplanes today is the slotted flap. Variations of this design are used for small airplanes as well as for large ones. Slotted flaps increase the lift coefficient significantly more than plain or split flaps. On small airplanes, the hinge is located below the lower surface of the flap, and when the flap is lowered, it forms a duct between the flap well in the wing and the leading edge of the flap.

When the slotted flap is lowered, high-energy air from the lower surface is ducted to the flap's upper surface. The high-energy air from the slot accelerates the upper surface boundary layer and delays airflow separation, providing a higher coefficient of lift. Thus, the slotted flap produces much greater increases in  $C_{L_{max}}$  than the plain or split flap. While there are many types of slotted flaps, large airplanes often have double- and even triple-slotted flaps. These allow the maximum increase in drag without the airflow over the flaps separating and destroying the lift they produce.

Fowler flaps are a type of slotted flap. This flap design not only changes the camber of the wing, it also increases the wing area. Instead of rotating down on a hinge, it slides backwards on tracks. In the first portion of its extension, it increases the drag very little, but increases the lift a great deal as it increases both the area and camber. As the extension continues, the flap deflects downward, and during the last portion of its travel, it increases the drag with little additional increase in lift.

### LEADING EDGE DEVICES

High-lift devices also can be applied to the leading edge of the airfoil. The most common types are fixed slots, movable slats, and leading edge flaps. [Figure 4-14]

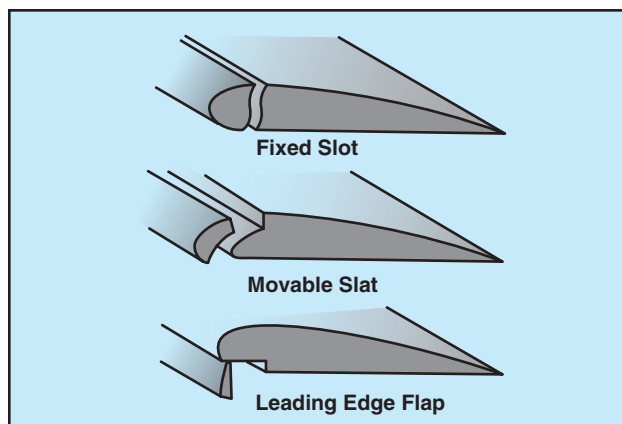

Figure 4-14. Leading edge high lift devices.

Fixed slots direct airflow to the upper wing surface and delay airflow separation at higher angles of attack. The slot does not increase the wing camber, but allows a higher maximum coefficient of lift because the stall is delayed until the wing reaches a greater angle of attack.

Movable slats consist of leading edge segments, which move on tracks. At low angles of attack, each slat is held flush against the wing's leading edge by the high pressure that forms at the wing's leading edge. As the angle of attack increases, the high-pressure area moves aft below the lower surface of the wing, allowing the slats to move forward. Some slats, however, are pilot operated and can be deployed at any angle of attack. Opening a slat allows the air below the wing to flow over the wing's upper surface, delaying airflow separation.

Leading edge flaps, like trailing edge flaps, are used to increase both  $C_{L_{max}}$  and the camber of the wings. This type of leading edge device is frequently used in conjunction with trailing edge flaps and can reduce the nose-down pitching movement produced by the latter. As is true with trailing edge flaps, a small increment of leading edge flaps increases lift to a much greater extent than drag. As greater amounts of flaps are extended, drag increases at a greater rate than lift.

### SPOILERS

On some airplanes, high-drag devices called spoilers are deployed from the wings to spoil the smooth airflow, reducing lift and increasing drag. Spoilers are used for roll control on some aircraft, one of the advantages being the elimination of adverse yaw. To turn right, for example, the spoiler on the right wing is raised, destroying some of the lift and creating more drag on the right. The right wing drops, and the airplane banks and yaws to the right. Deploying spoilers on both wings at the same time allows the aircraft to descend without gaining speed. Spoilers are also deployed to help shorten ground roll after landing. By destroying lift, they transfer weight to the wheels, improving braking effectiveness. [Figure 4-15]



Figure 4-15. Spoilers reduce lift and increase drag during descent and landing.

## TRIM SYSTEMS

Although the airplane can be operated throughout a wide range of attitudes, airspeeds, and power settings, it can only be designed to fly hands off within a very limited combination of these variables. Therefore, trim systems are used to relieve the pilot of the need to maintain constant pressure on the flight controls. Trim systems usually consist of cockpit controls and small hinged devices attached to the trailing edge of one or more of the primary flight control surfaces. They are designed to help minimize a pilot's workload by aerodynamically assisting movement and position of the flight control surface to which they are attached. Common types of trim systems include trim tabs, balance tabs, antiservo tabs, ground adjustable tabs, and an adjustable stabilizer.

### TRIM TABS

The most common installation on small airplanes is a single trim tab attached to the trailing edge of the elevator. Most trim tabs are manually operated by a small, vertically mounted control wheel. However, a trim crank may be found in some airplanes. The cockpit control includes a tab position indicator. Placing the trim control in the full nose-down position moves the tab to its full up position. With the tab up and into the airstream, the airflow over the horizontal tail surface tends to force the trailing edge of the elevator down. This causes the tail of the airplane to move up, and results in a nose-down pitch change. [Figure 4-16]

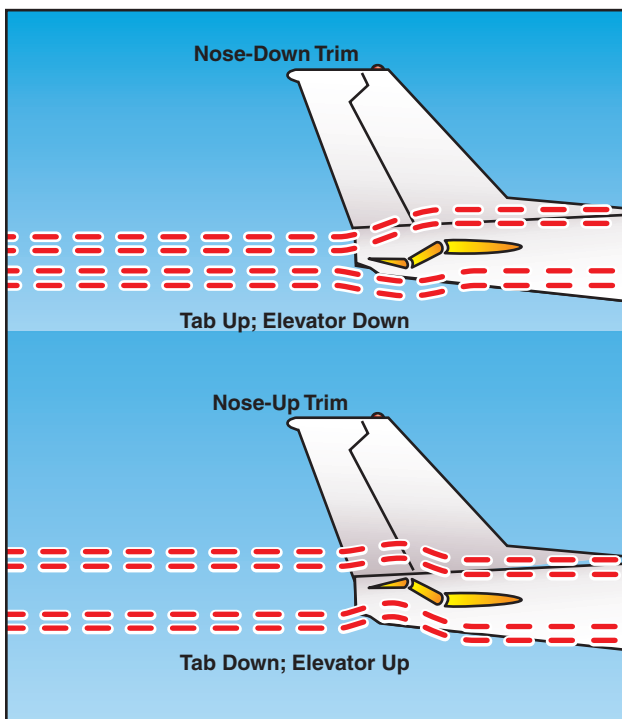

Figure 4-16. The movement of the elevator is opposite to the direction of movement of the elevator trim tab.

If you set the trim tab to the full nose-up position, the tab moves to its full-down position. In this case, the air flowing under the horizontal tail surface hits the tab and tends to force the trailing edge of the elevator up, reducing the elevator's angle of attack. This causes a tail-down movement of the airplane and a nose-up pitch change.

In spite of the opposite direction movement of the trim tab and the elevator, control of trim is natural to a pilot. If you have to exert constant back pressure on the control column, the need for nose-up trim is indicated. The normal trim procedure is to continue trimming until the airplane is balanced and the nose-heavy condition is no longer apparent. Pilots normally establish the desired power, pitch attitude, and configuration first, and then trim the airplane to relieve control pressures that may exist for that flight condition. Any time power, pitch attitude, or configuration is changed, expect that retrimming will be necessary to relieve the control pressures for the new flight condition.

### BALANCE TABS

The control forces may be excessively high in some airplanes, and in order to decrease them, the manufacturer may use balance tabs. They look like trim tabs and are hinged in approximately the same places as trim tabs. The essential difference between the two is that the balancing tab is coupled to the control surface rod so that when the primary control surface is moved in any direction, the tab automatically moves in the opposite direction. In this manner, the airflow striking the tab counter-balances some of the air pressure against the primary control surface, and enables the pilot to more easily move and hold the control surface in position.

If the linkage between the tab and the fixed surface is adjustable from the cockpit, the tab acts as a combination trim and balance tab, which can be adjusted to any desired deflection. Any time the control surface is deflected, the tab moves in the opposite direction and eases the load on the pilot.

### ANTISERVO TABS

In addition to decreasing the sensitivity of the stabilator, an antiservo tab also functions as a trim device to relieve control pressure and maintain the stabilator in the desired position. The fixed end of the linkage is on the opposite side of the surface from the horn on the tab, and when the trailing edge of the stabilator moves up, the linkage forces the trailing edge of the tab up. When the stabilator moves down, the tab also moves down. This is different than trim tabs on elevators, which move opposite of the control surface. [Figure 4-17]

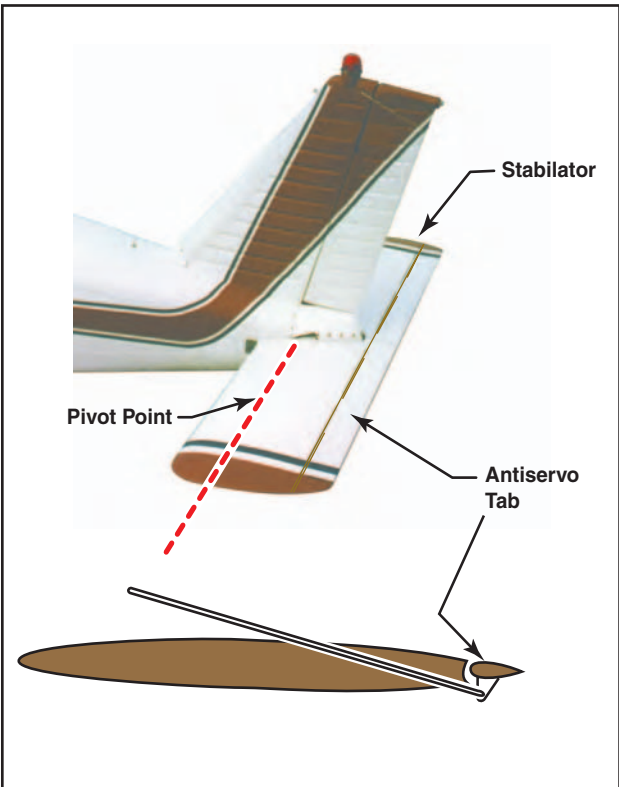

Figure 4-17. An antiservo tab attempts to streamline the control surface and is used to make the stabilizer less sensitive by opposing the force exerted by the pilot.

This tab works in the same manner as the balance tab except that, instead of moving in the opposite direction, it moves in the same direction as the trailing edge of the stabilizer. For example, when the trailing edge of the stabilizer moves up, the linkage forces the trailing edge of the tab up. When the stabilizer moves down, the tab also moves down.

### GROUND ADJUSTABLE TABS

Many small airplanes have a non-moveable metal trim tab on the rudder. This tab is bent in one direction or the other while on the ground to apply a trim force to the rudder. The correct displacement is determined by trial-and-error process. Usually, small adjustments are necessary until you are satisfied that the airplane is no longer skidding left or right during normal cruising flight. [Figure 4-18]

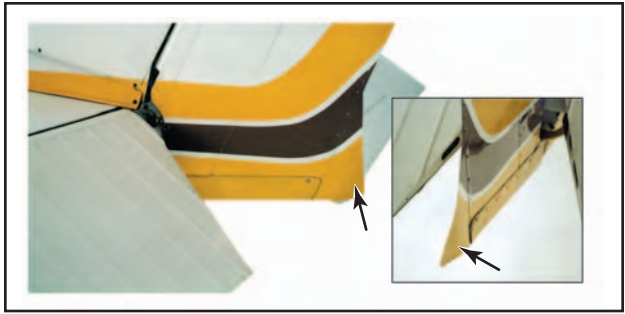

Figure 4-18. A ground-adjustable tab is used on the rudder of many small airplanes to correct for a tendency to fly with the fuselage slightly misaligned with the relative wind.

### ADJUSTABLE STABILIZER

Rather than using a movable tab on the trailing edge of the elevator, some airplanes have an adjustable stabilizer. With this arrangement, linkages pivot the horizontal stabilizer about its rear spar. This is accomplished by use of a jackscrew mounted on the leading edge of the stabilizer. [Figure 4-19]

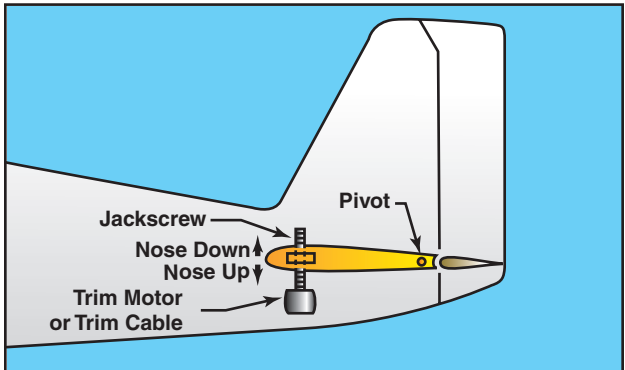
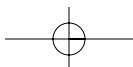
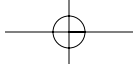

Figure 4-19. Some airplanes, including most jet transports, use an adjustable stabilizer to provide the required pitch trim forces.

On small airplanes, the jackscrew is cable-operated with a trim wheel or crank, and on larger airplanes, it is motor driven. The trimming effect and cockpit indications for an adjustable stabilizer are similar to those of a trim tab.

Since the primary and secondary flight control systems vary extensively between aircraft, you need to be familiar with the systems in your aircraft. A good source of information is the Airplane Flight Manual (AFM) or the Pilot's Operating Handbook (POH).





## Chapter 5

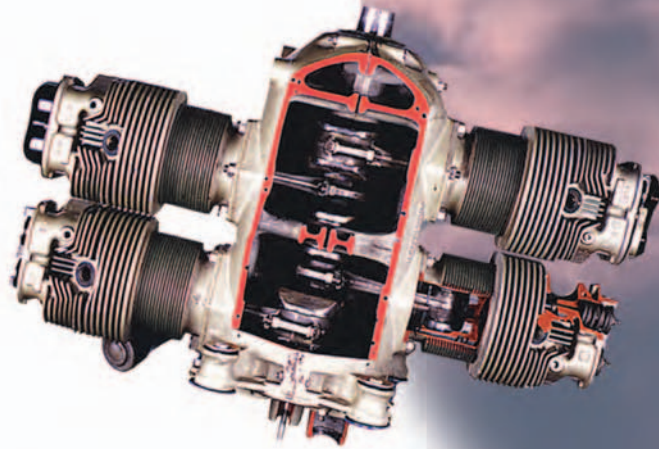

# Aircraft Systems

This chapter covers the main systems found on small airplanes. These include the engine, propeller, and induction systems, as well as the ignition, fuel, lubrication, cooling, electrical, landing gear, autopilot, and environmental control systems. A comprehensive introduction to gas turbine engines is included at the end of this chapter.

### POWERPLANT

The airplane engine and propeller, often referred to as a **powerplant**, work in combination to produce thrust. The powerplant propels the airplane and drives the various systems that support the operation of an airplane.

### RECIPROCATING ENGINES

Most small airplanes are designed with reciprocating engines. The name is derived from the back-and-forth, or reciprocating, movement of the pistons. It is this motion that produces the mechanical energy needed to accomplish work. Two common means of classifying reciprocating engines are:

1. by cylinder arrangement with respect to the crankshaft—radial, in-line, v-type or opposed, or
2. by the method of cooling—liquid or air-cooled.

**Powerplant**—A complete engine and propeller combination with accessories.

Radial engines were widely used during World War II, and many are still in service today. With these engines, a row or rows of cylinders are arranged in a circular pattern around the crankcase. The main advantage of a radial engine is the favorable power-to-weight ratio.

In-line engines have a comparatively small frontal area, but their power-to-weight ratios are relatively low. In addition, the rearmost cylinders of an air-cooled, in-line engine receive very little cooling air, so these engines are normally limited to four or six cylinders. V-type engines provide more horsepower than in-line engines and still retain a small frontal area. Further improvements in engine design led to the development of the horizontally-opposed engine.

Opposed-type engines are the most popular reciprocating engines used on small airplanes. These engines always have an even number of cylinders, since a cylinder on one side of the crankcase “opposes” a cylinder on the other side. The majority of these engines are air cooled and usually are mounted in a horizontal position when installed on fixed-wing airplanes. Opposed-type engines have high power-to-weight ratios because they have a comparatively small, lightweight crankcase. In addition, the compact cylinder arrangement reduces the engine’s frontal area and allows a streamlined installation that minimizes aerodynamic drag.

The main parts of a reciprocating engine include the cylinders, crankcase, and accessory housing. The intake/exhaust valves, spark plugs, and pistons are located in the cylinders. The crankshaft and connecting rods are located in the crankcase. [Figure 5-1] The magnetos are normally located on the engine accessory housing.

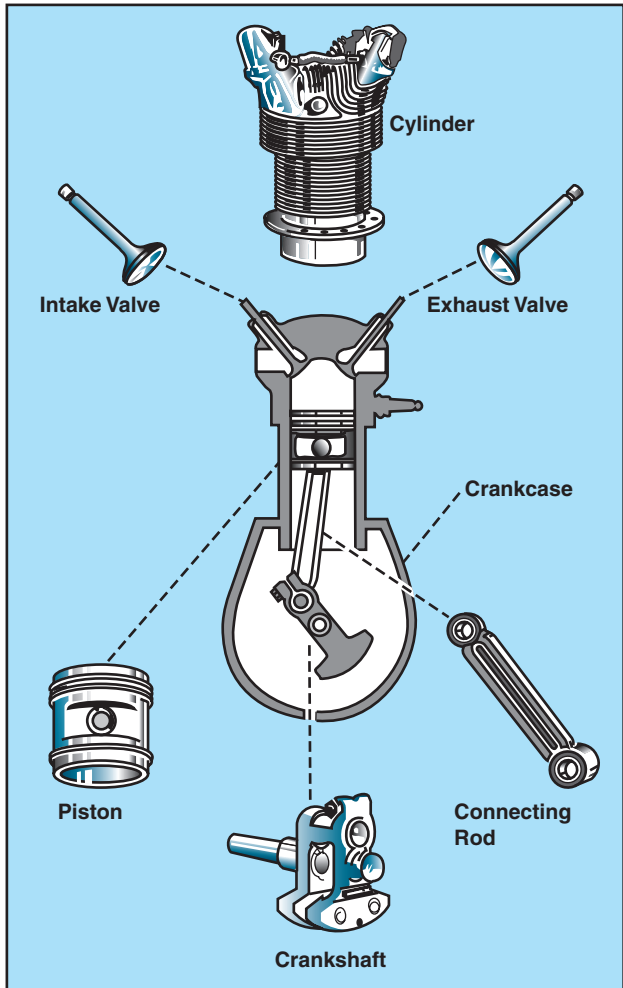

Figure 5-1. Main components of a reciprocating engine.

The basic principle for reciprocating engines involves the conversion of chemical energy, in the form of fuel, into mechanical energy. This occurs within the cylinders of the engine through a process known as the four-stroke operating cycle. These strokes are called intake, compression, power, and exhaust. [Figure 5-2]

1. The intake stroke begins as the piston starts its downward travel. When this happens, the intake valve opens and the fuel/air mixture is drawn into the cylinder.
2. The compression stroke begins when the intake valve closes and the piston starts moving back to the top of the cylinder. This phase of the cycle is used to obtain a much greater power output from the fuel/air mixture once it is ignited.

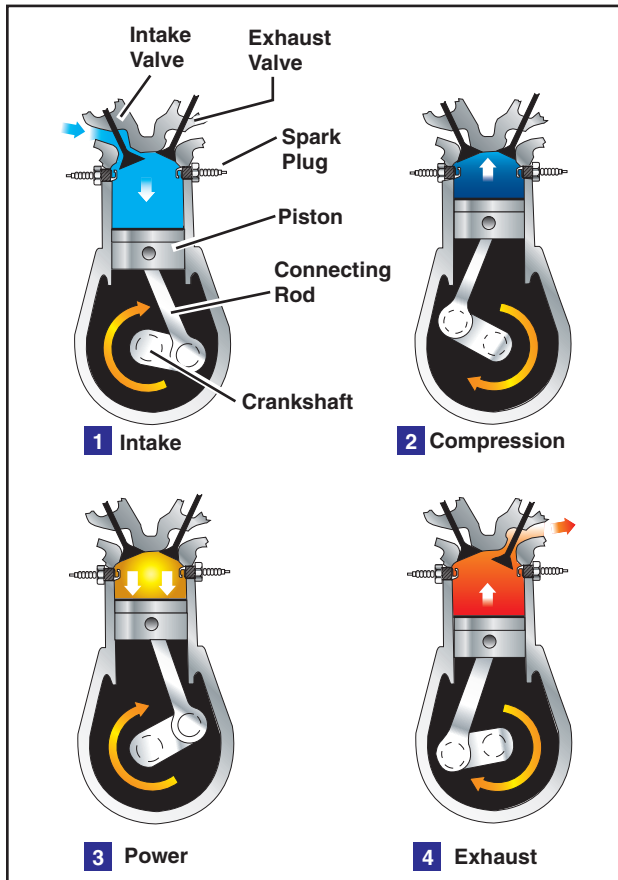

Figure 5-2. The arrows in this illustration indicate the direction of motion of the crankshaft and piston during the four-stroke cycle.

3. The power stroke begins when the fuel/air mixture is ignited. This causes a tremendous pressure increase in the cylinder, and forces the piston downward away from the cylinder head, creating the power that turns the crankshaft.
4. The exhaust stroke is used to purge the cylinder of burned gases. It begins when the exhaust valve opens and the piston starts to move toward the cylinder head once again.

Even when the engine is operated at a fairly low speed, the four-stroke cycle takes place several hundred times each minute. In a four-cylinder engine, each cylinder operates on a different stroke. Continuous rotation of a crankshaft is maintained by the precise timing of the power strokes in each cylinder. Continuous operation of the engine depends on the simultaneous function of auxiliary systems, including the induction, ignition, fuel, oil, cooling, and exhaust systems.

### PROPELLER

The propeller is a rotating airfoil, subject to induced drag, stalls, and other aerodynamic principles that apply to any airfoil. It provides the necessary thrust to pull, or in some cases push, the airplane through the air. The engine power is used to rotate the propeller, which

in turn generates thrust very similar to the manner in which a wing produces lift. The amount of thrust produced depends on the shape of the airfoil, the angle of attack of the propeller blade, and the r.p.m. of the engine. The propeller itself is twisted so the blade angle changes from hub to tip. The greatest **angle of incidence**, or the highest pitch, is at the hub while the smallest pitch is at the tip. [Figure 5-3]

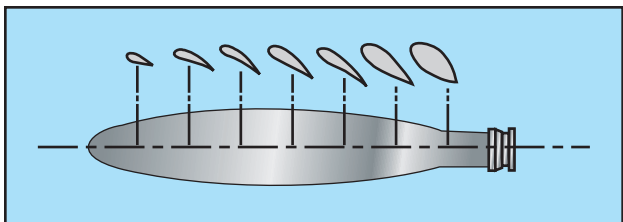

**Figure 5-3. Changes in propeller blade angle from hub to tip.**

The reason for the twist is to produce uniform lift from the hub to the tip. As the blade rotates, there is a difference in the actual speed of the various portions of the blade. The tip of the blade travels faster than that part near the hub, because the tip travels a greater distance than the hub in the same length of time. Changing the angle of incidence (pitch) from the hub to the tip to correspond with the speed produces uniform lift throughout the length of the blade. If the propeller blade was designed with the same angle of incidence throughout its entire length, it would be inefficient, because as airspeed increases in flight, the portion near the hub would have a negative angle of attack while the blade tip would be stalled. [Figure 5-4]

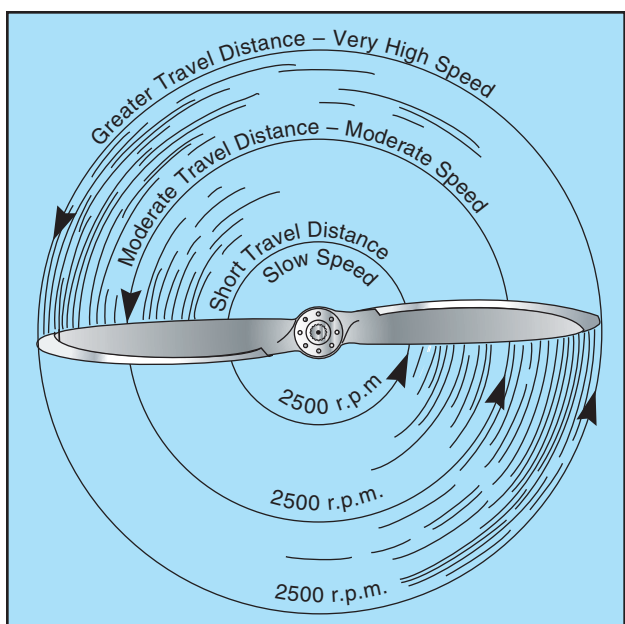

**Figure 5-4. Relationship of travel distance and speed of various portions of propeller blade.**

**Angle of Incidence**—For a propeller, it is the angle formed by the chord line and the reference plane containing the propeller hub. For a wing, it is the angle formed by the chord line of the wing and the longitudinal axis of the airplane.

Small airplanes are equipped with either one of two types of propellers. One is the fixed-pitch, and the other is the controllable-pitch.

### FIXED-PITCH PROPELLER

The pitch of this propeller is set by the manufacturer, and cannot be changed. With this type of propeller, the best efficiency is achieved only at a given combination of airspeed and r.p.m.

There are two types of fixed-pitch propellers—the climb propeller and the cruise propeller. Whether the airplane has a climb or cruise propeller installed depends upon its intended use:

- The climb propeller has a lower pitch, therefore less drag. Less drag results in higher r.p.m. and more horsepower capability, which increases performance during takeoffs and climbs, but decreases performance during cruising flight.
- The cruise propeller has a higher pitch, therefore more drag. More drag results in lower r.p.m. and less horsepower capability, which decreases performance during takeoffs and climbs, but increases efficiency during cruising flight.

The propeller is usually mounted on a shaft, which may be an extension of the engine crankshaft. In this case, the r.p.m. of the propeller would be the same as the crankshaft r.p.m. On some engines, the propeller is mounted on a shaft geared to the engine crankshaft. In this type, the r.p.m. of the propeller is different than that of the engine. In a fixed-pitch propeller, the tachometer is the indicator of engine power. [Figure 5-5]



**Figure 5-5. Engine r.p.m. is indicated on the tachometer.**

A tachometer is calibrated in hundreds of r.p.m., and gives a direct indication of the engine and propeller r.p.m. The instrument is color-coded, with a green arc denoting the maximum continuous operating r.p.m. Some tachometers have additional markings to reflect

engine and/or propeller limitations. Therefore, the manufacturer's recommendations should be used as a reference to clarify any misunderstanding of tachometer markings.

The revolutions per minute are regulated by the throttle, which controls the fuel/air flow to the engine. At a given altitude, the higher the tachometer reading, the higher the power output of the engine.

When operating altitude increases, the tachometer may not show correct power output of the engine. For example, 2,300 r.p.m. at 5,000 feet produce less horsepower than 2,300 r.p.m. at sea level. The reason for this is that power output depends on air density. Air density decreases as altitude increases. Therefore, a decrease in air density (higher density altitude) decreases the power output of the engine. As altitude changes, the position of the throttle must be changed to maintain the same r.p.m. As altitude is increased, the throttle must be opened further to indicate the same r.p.m. as at a lower altitude.

### ADJUSTABLE-PITCH PROPELLER

Although some older adjustable-pitch propellers could only be adjusted on the ground, most modern adjustable-pitch propellers are designed so that you can change the propeller pitch in flight. The first adjustable-pitch propeller systems provided only two pitch settings—a low-pitch setting and a high-pitch setting. Today, however, nearly all adjustable-pitch propeller systems are capable of a range of pitch settings.

A constant-speed propeller is the most common type of adjustable-pitch propeller. The main advantage of a constant-speed propeller is that it converts a high percentage of brake horsepower (BHP) into thrust horsepower (THP) over a wide range of r.p.m. and airspeed combinations. A constant-speed propeller is more efficient than other propellers because it allows selection of the most efficient engine r.p.m. for the given conditions.

An airplane with a constant-speed propeller has two controls—the throttle and the propeller control. The throttle controls power output, and the propeller control regulates engine r.p.m. and, in turn, propeller r.p.m., which is registered on the tachometer.

Once a specific r.p.m. is selected, a governor automatically adjusts the propeller blade angle as necessary to maintain the selected r.p.m. For example, after setting the desired r.p.m. during cruising flight, an increase in airspeed or decrease in propeller load will cause the propeller blade angle to increase as necessary to maintain the selected r.p.m. A reduction in airspeed or increase in propeller load will cause the propeller blade angle to decrease.

The range of possible blade angles for a constant-speed propeller is the propeller's constant-speed range and is defined by the high and low pitch stops. As long as the propeller blade angle is within the constant-speed range and not against either pitch stop, a constant engine r.p.m. will be maintained. However, once the propeller blades contact a pitch stop, the engine r.p.m. will increase or decrease as appropriate, with changes in airspeed and propeller load. For example, once a specific r.p.m. has been selected, if aircraft speed decreases enough to rotate the propeller blades until they contact the low pitch stop, any further decrease in airspeed will cause engine r.p.m. to decrease the same way as if a fixed-pitch propeller were installed. The same holds true when an airplane equipped with a constant-speed propeller accelerates to a faster airspeed. As the aircraft accelerates, the propeller blade angle increases to maintain the selected r.p.m. until the high pitch stop is reached. Once this occurs, the blade angle cannot increase any further and engine r.p.m. increases.

On airplanes that are equipped with a constant-speed propeller, power output is controlled by the throttle and indicated by a manifold pressure gauge. The gauge measures the absolute pressure of the fuel/air mixture inside the intake manifold and is more correctly a measure of **manifold absolute pressure (MAP)**. At a constant r.p.m. and altitude, the amount of power produced is directly related to the fuel/air flow being delivered to the combustion chamber. As you increase the throttle setting, more fuel and air is flowing to the engine; therefore, MAP increases. When the engine is not running, the manifold pressure gauge indicates ambient air pressure (i.e., 29.92 in. Hg). When the engine is started, the manifold pressure indication will decrease to a value less than ambient pressure (i.e., idle at 12 in. Hg). Correspondingly, engine failure or power loss is indicated on the manifold gauge as an increase in manifold pressure to a value corresponding to the ambient air pressure at the altitude where the failure occurred. [Figure 5-6]

The manifold pressure gauge is color-coded to indicate the engine's operating range. The face of the manifold pressure gauge contains a green arc to show the normal operating range, and a red radial line to indicate the upper limit of manifold pressure.

For any given r.p.m., there is a manifold pressure that should not be exceeded. If manifold pressure is excessive for a given r.p.m., the pressure within the cylinders could be exceeded, thus placing undue stress on the cylinders. If repeated too frequently, this stress could weaken the cylinder components, and eventually cause engine failure.

**Manifold Absolute Pressure (MAP)**—The absolute pressure of the fuel/air mixture within the intake manifold, usually indicated in inches of mercury.





**Figure 5-6.** Engine power output is indicated on the manifold pressure gauge.

You can avoid conditions that could overstress the cylinders by being constantly aware of the r.p.m., especially when increasing the manifold pressure. Conform to the manufacturer's recommendations for power settings of a particular engine so as to maintain the proper relationship between manifold pressure and r.p.m.

When both manifold pressure and r.p.m. need to be changed, avoid engine overstress by making power adjustments in the proper order:

- When power settings are being decreased, reduce manifold pressure before reducing r.p.m. If r.p.m. is reduced before manifold pressure, manifold pressure will automatically increase and possibly exceed the manufacturer's tolerances.
- When power settings are being increased, reverse the order—increase r.p.m. first, then manifold pressure.
- To prevent damage to radial engines, operating time at maximum r.p.m. and manifold pressure must be held to a minimum, and operation at maximum r.p.m. and low manifold pressure must be avoided.

Under normal operating conditions, the most severe wear, fatigue, and damage to high performance reciprocating engines occurs at high r.p.m. and low manifold pressure.

### INDUCTION SYSTEMS

The induction system brings in air from the outside, mixes it with fuel, and delivers the fuel/air mixture to the cylinder where combustion occurs. Outside air enters the induction system through an intake port on the front of the engine cowling. This port normally contains an air filter that inhibits the entry of dust and other foreign objects. Since the filter may occasionally

become clogged, an alternate source of air must be available. Usually, the alternate air comes from inside the engine cowling, where it bypasses a clogged air filter. Some alternate air sources function automatically, while others operate manually.

Two types of induction systems are commonly used in small airplane engines:

1. the carburetor system, which mixes the fuel and air in the carburetor before this mixture enters the intake manifold, and
2. the fuel injection system, which mixes the fuel and air just before entry into each cylinder.

### CARBURETOR SYSTEMS

Carburetors are classified as either float-type or pressure-type. Pressure carburetors are usually not found on small airplanes. The basic difference between a pressure carburetor and a float-type is the pressure carburetor delivers fuel under pressure by a fuel pump.

In the operation of the float-type carburetor system, the outside air first flows through an air filter, usually located at an air intake in the front part of the engine cowling. This filtered air flows into the carburetor and through a venturi, a narrow throat in the carburetor. When the air flows through the venturi, a low-pressure area is created, which forces the fuel to flow through a main fuel jet located at the throat. The fuel then flows into the airstream, where it is mixed with the flowing air. See figure 5-7 on page 5-6.

The fuel/air mixture is then drawn through the intake manifold and into the combustion chambers, where it is ignited. The "float-type carburetor" acquires its name from a float, which rests on fuel within the float chamber. A needle attached to the float opens and closes an opening at the bottom of the carburetor bowl. This meters the correct amount of fuel into the carburetor, depending upon the position of the float, which is controlled by the level of fuel in the float chamber. When the level of the fuel forces the float to rise, the needle valve closes the fuel opening and shuts off the fuel flow to the carburetor. The needle valve opens again when the engine requires additional fuel. The flow of the fuel/air mixture to the combustion chambers is regulated by the throttle valve, which is controlled by the throttle in the cockpit.

### MIXTURE CONTROL

Carburetors are normally calibrated at sea-level pressure, where the correct fuel-to-air mixture ratio is established with the mixture control set in the FULL RICH position. However, as altitude increases, the density of air entering the carburetor decreases, while the density of the fuel remains the same. This creates a

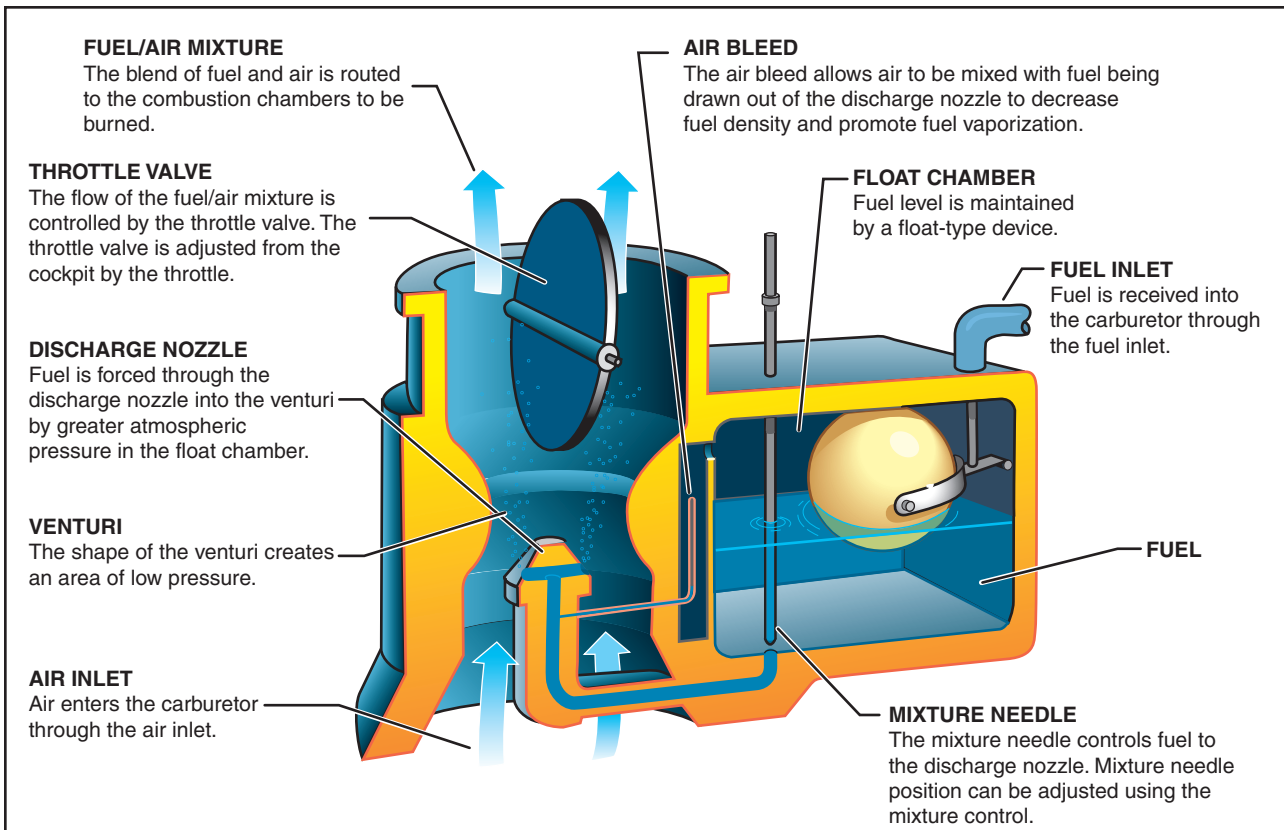
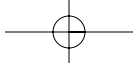

Figure 5-7. Float-type carburetor.

progressively richer mixture, which can result in engine roughness and an appreciable loss of power. The roughness normally is due to spark plug fouling from excessive carbon buildup on the plugs. Carbon buildup occurs because the excessively rich mixture lowers the temperature inside the cylinder, inhibiting complete combustion of the fuel. This condition may occur during the pretakeoff runup at high-elevation airports and during climbs or cruise flight at high altitudes. To maintain the correct fuel/air mixture, you must lean the mixture using the mixture control. Leaning the mixture decreases fuel flow, which compensates for the decreased air density at high altitude.

During a descent from high altitude, the opposite is true. The mixture must be enriched, or it may become too lean. An overly lean mixture causes detonation, which may result in rough engine operation, overheating, and a loss of power. The best way to maintain the proper mixture is to monitor the engine temperature and enrichen the mixture as needed. Proper mixture control and better fuel economy for fuel-injected engines can be achieved by use of an exhaust gas temperature gauge. Since the process of adjusting the mixture can vary from one airplane to another, it is important to refer to the Airplane Flight Manual (AFM) or the Pilot's Operating Handbook (POH) to determine the specific procedures for a given airplane.

**CARBURETOR ICING**

One disadvantage of the float-type carburetor is its icing tendency. Carburetor ice occurs due to the effect of fuel vaporization and the decrease in air pressure in the venturi, which causes a sharp temperature drop in the carburetor. If water vapor in the air condenses when the carburetor temperature is at or below freezing, ice may form on internal surfaces of the carburetor, including the throttle valve. [Figure 5-8]

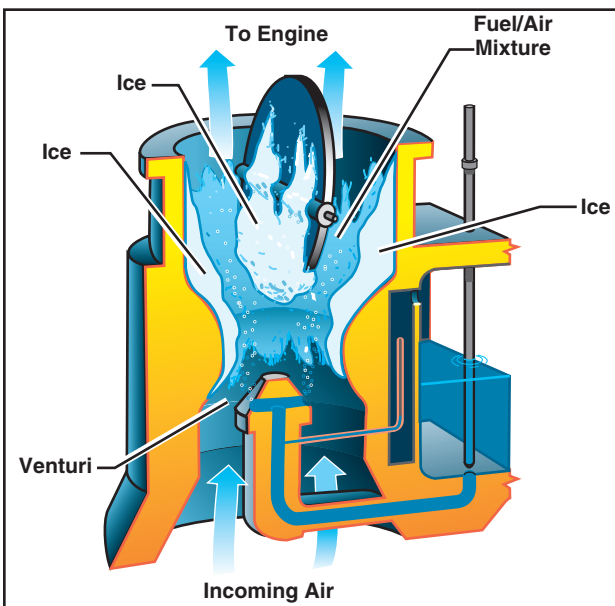
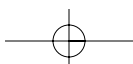
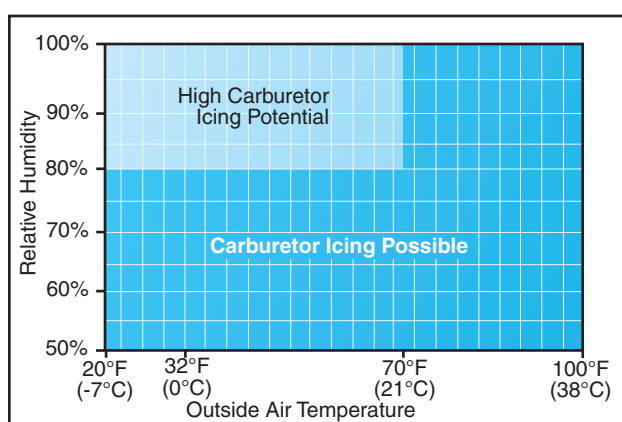

Figure 5-8. The formation of carburetor ice may reduce or block fuel/air flow to the engine.



The reduced air pressure, as well as the vaporization of fuel, contributes to the temperature decrease in the carburetor. Ice generally forms in the vicinity of the throttle valve and in the venturi throat. This restricts the flow of the fuel/air mixture and reduces power. If enough ice builds up, the engine may cease to operate.

Carburetor ice is most likely to occur when temperatures are below 70°F (21°C) and the relative humidity is above 80 percent. However, due to the sudden cooling that takes place in the carburetor, icing can occur even with temperatures as high as 100°F (38°C) and humidity as low as 50 percent. This temperature drop can be as much as 60 to 70°F. Therefore, at an outside air temperature of 100°F, a temperature drop of 70°F results in an air temperature in the carburetor of 30°F. [Figure 5-9]



**Figure 5-9.** Although carburetor ice is most likely to form when the temperature and humidity are in ranges indicated by this chart, carburetor ice is possible under conditions not depicted.

The first indication of carburetor icing in an airplane with a fixed-pitch propeller is a decrease in engine r.p.m., which may be followed by engine roughness. In an airplane with a constant-speed propeller, carburetor icing usually is indicated by a decrease in manifold pressure, but no reduction in r.p.m. Propeller pitch is automatically adjusted to compensate for loss of power. Thus, a constant r.p.m. is maintained. Although carburetor ice can occur during any phase of flight, it is particularly dangerous when using reduced power during a descent. Under certain conditions, carburetor ice could build unnoticed until you try to add power. To combat the effects of carburetor ice, engines with float-type carburetors employ a carburetor heat system.

### CARBURETOR HEAT

Carburetor heat is an anti-icing system that preheats the air before it reaches the carburetor. Carburetor heat is intended to keep the fuel/air mixture above the freezing temperature to prevent the formation of carburetor ice. Carburetor heat can be used to melt ice that has already formed in the carburetor provided that the accumulation is not too great. The

emphasis, however, is on using carburetor heat as a preventative measure.

The carburetor heat should be checked during the engine runup. When using carburetor heat, follow the manufacturer's recommendations.

When conditions are conducive to carburetor icing during flight, periodic checks should be made to detect its presence. If detected, full carburetor heat should be applied immediately, and it should be left in the ON position until you are certain that all the ice has been removed. If ice is present, applying partial heat or leaving heat on for an insufficient time might aggravate the situation. In extreme cases of carburetor icing, even after the ice has been removed, full carburetor heat should be used to prevent further ice formation. A carburetor temperature gauge, if installed, is very useful in determining when to use carburetor heat.

Whenever the throttle is closed during flight, the engine cools rapidly and vaporization of the fuel is less complete than if the engine is warm. Also, in this condition, the engine is more susceptible to carburetor icing. Therefore, if you suspect carburetor icing conditions and anticipate closed-throttle operation, adjust the carburetor heat to the full ON position before closing the throttle, and leave it on during the closed-throttle operation. The heat will aid in vaporizing the fuel, and help prevent the formation of carburetor ice. Periodically, open the throttle smoothly for a few seconds to keep the engine warm, otherwise the carburetor heater may not provide enough heat to prevent icing.

The use of carburetor heat causes a decrease in engine power, sometimes up to 15 percent, because the heated air is less dense than the outside air that had been entering the engine. This enriches the mixture. When ice is present in an airplane with a fixed-pitch propeller and carburetor heat is being used, there is a decrease in r.p.m., followed by a gradual increase in r.p.m. as the ice melts. The engine also should run more smoothly after the ice has been removed. If ice is not present, the r.p.m. will decrease, then remain constant. When carburetor heat is used on an airplane with a constant-speed propeller, and ice is present, a decrease in the manifold pressure will be noticed, followed by a gradual increase. If carburetor icing is not present, the gradual increase in manifold pressure will not be apparent until the carburetor heat is turned off.

It is imperative that a pilot recognizes carburetor ice when it forms during flight. In addition, a loss of power, altitude, and/or airspeed will occur. These symptoms may sometimes be accompanied by vibration or engine roughness. Once a power loss is noticed, immediate action should be taken to eliminate

ice already formed in the carburetor, and to prevent further ice formation. This is accomplished by applying full carburetor heat, which will cause a further reduction in power, and possibly engine roughness as melted ice goes through the engine. These symptoms may last from 30 seconds to several minutes, depending on the severity of the icing. During this period, the pilot must resist the temptation to decrease the carburetor heat usage. Carburetor heat must remain in the full-hot position until normal power returns.

Since the use of carburetor heat tends to reduce the output of the engine and also to increase the operating temperature, carburetor heat should not be used when full power is required (as during takeoff) or during normal engine operation, except to check for the presence or to remove carburetor ice.

#### CARBURETOR AIR TEMPERATURE GAUGE

Some airplanes are equipped with a carburetor air temperature gauge, which is useful in detecting potential icing conditions. Usually, the face of the gauge is calibrated in degrees Celsius ( $^{\circ}\text{C}$ ), with a yellow arc indicating the carburetor air temperatures where icing may occur. This yellow arc typically ranges between  $-15^{\circ}\text{C}$  and  $+5^{\circ}\text{C}$  ( $5^{\circ}\text{F}$  and  $41^{\circ}\text{F}$ ). If the air temperature and moisture content of the air are such that carburetor icing is improbable, the engine can be operated with the indicator in the yellow range with no adverse effects. However, if the atmospheric conditions are conducive to carburetor icing, the indicator must be kept outside the yellow arc by application of carburetor heat.

Certain carburetor air temperature gauges have a red radial, which indicates the maximum permissible carburetor inlet air temperature recommended by the engine manufacturer; also, a green arc may be included to indicate the normal operating range.

#### OUTSIDE AIR TEMPERATURE GAUGE

Most airplanes also are equipped with an outside air temperature (OAT) gauge calibrated in both degrees Celsius and Fahrenheit. It provides the outside or ambient air temperature for calculating true airspeed, and also is useful in detecting potential icing conditions.

#### FUEL INJECTION SYSTEMS

In a fuel injection system, the fuel is injected either directly into the cylinders, or just ahead of the intake valve. A fuel injection system is considered to be less susceptible to icing than the carburetor system. Impact icing on the air intake, however, is a possibility in either system. Impact icing occurs when ice forms on the exterior of the airplane, and blocks openings such as the air intake for the injection system.

The air intake for the fuel injection system is similar to that used in the carburetor system, with an alternate air source located within the engine cowling. This source is used if the external air source is obstructed. The alternate air source is usually operated automatically, with a backup manual system that can be used if the automatic feature malfunctions.

A fuel injection system usually incorporates these basic components—an engine-driven fuel pump, a fuel/air control unit, fuel manifold (fuel distributor), discharge nozzles, an auxiliary fuel pump, and fuel pressure/flow indicators. [Figure 5-10]

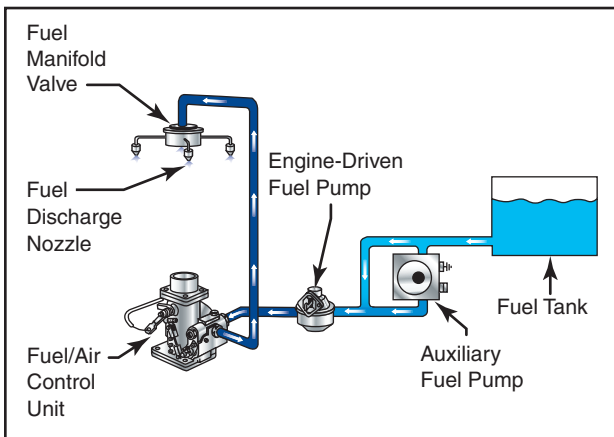

Figure 5-10. Fuel injection system.

The auxiliary fuel pump provides fuel under pressure to the fuel/air control unit for engine starting and/or emergency use. After starting, the engine-driven fuel pump provides fuel under pressure from the fuel tank to the fuel/air control unit. This control unit, which essentially replaces the carburetor, meters fuel based on the mixture control setting, and sends it to the fuel manifold valve at a rate controlled by the throttle. After reaching the fuel manifold valve, the fuel is distributed to the individual fuel discharge nozzles. The discharge nozzles, which are located in each cylinder head, inject the fuel/air mixture directly into each cylinder intake port.

Some of the advantages of fuel injection are:

- Reduction in evaporative icing.
- Better fuel flow.
- Faster throttle response.
- Precise control of mixture.
- Better fuel distribution.
- Easier cold weather starts.



Disadvantages usually include:

- Difficulty in starting a hot engine.
- Vapor locks during ground operations on hot days.
- Problems associated with restarting an engine that quits because of fuel starvation.

## SUPERCHARGERS AND TURBOSUPERCHARGERS

To increase an engine's horsepower, manufacturers have developed supercharger and turbosupercharger systems that compress the intake air to increase its density. Airplanes with these systems have a manifold pressure gauge, which displays manifold absolute pressure (MAP) within the engine's intake manifold.

On a standard day at sea level with the engine shut down, the manifold pressure gauge will indicate the ambient absolute air pressure of 29.92 in. Hg. Because atmospheric pressure decreases approximately 1 in. Hg per 1,000 feet of altitude increase, the manifold pressure gauge will indicate approximately 24.92 in. Hg at an airport that is 5,000 feet above sea level with standard day conditions.

As a normally aspirated aircraft climbs, it eventually reaches an altitude where the MAP is insufficient for a normal climb. That altitude limit is the aircraft's **service ceiling**, and it is directly affected by the engine's ability to produce power. If the induction air entering the engine is pressurized, or boosted, by either a supercharger or a turbosupercharger, the aircraft's service ceiling can be increased. With these systems, you can fly at higher altitudes with the advantage of higher true airspeeds and the increased ability to circumnavigate adverse weather.

### SUPERCHARGERS

A **supercharger** is an engine-driven air pump or compressor that increases manifold pressure and forces the fuel/air mixture into the cylinders. The higher the manifold pressure, the more dense the fuel/air mixture, and the more power an engine can produce. With a normally aspirated engine, it is not possible to have manifold pressure higher than the existing atmospheric pressure. A supercharger is capable of boosting manifold pressure above 30 in. Hg.

**Service Ceiling**—The maximum density altitude where the best rate-of-climb airspeed will produce a 100 feet-per-minute climb at maximum weight while in a clean configuration with maximum continuous power.

**Supercharger**—An engine-driven air compressor used to provide additional pressure to the induction air so the engine can produce additional power.

The components in a supercharged induction system are similar to those in a normally aspirated system, with the addition of a supercharger between the fuel metering device and intake manifold. A supercharger is driven by the engine through a gear train at one speed, two speeds, or variable speeds. In addition, superchargers can have one or more stages. Each stage provides an increase in pressure. Therefore, superchargers may be classified as single stage, two stage, or multistage, depending on the number of times compression occurs.

An early version of a single-stage, single-speed supercharger may be referred to as a sea-level supercharger. An engine equipped with this type of supercharger is called a **sea-level engine**. With this type of supercharger, a single gear-driven impeller is used to increase the power produced by an engine at all altitudes. The drawback, however, is that with this type of supercharger, engine power output still decreases with an increase in altitude, in the same way that it does with a normally aspirated engine.

Single-stage, single-speed superchargers are found on many high-powered radial engines, and use an air intake that faces forward so the induction system can take full advantage of the ram air. Intake air passes through ducts to a carburetor, where fuel is metered in proportion to the airflow. The fuel/air charge is then ducted to the supercharger, or blower impeller, which accelerates the fuel/air mixture outward. Once accelerated, the fuel/air mixture passes through a diffuser, where air velocity is traded for pressure energy. After compression, the resulting high pressure fuel/air mixture is directed to the cylinders.

Some of the large radial engines developed during World War II have a single-stage, two-speed supercharger. With this type of supercharger, a single impeller may be operated at two speeds. The low impeller speed is often referred to as the low blower setting, while the high impeller speed is called the high blower setting. On engines equipped with a two-speed supercharger, a lever or switch in the cockpit activates an oil-operated clutch that switches from one speed to the other.

Under normal operations, takeoff is made with the supercharger in the low blower position. In this mode, the engine performs as a ground-boosted engine, and the power output decreases as the aircraft gains altitude. However, once the aircraft reaches a specified altitude, a power reduction is made, and the supercharger control is switched to the high blower position. The throttle is then reset to the desired

**Sea-Level Engine**—A reciprocating aircraft engine having a rated takeoff power that is producible only at sea level.

manifold pressure. An engine equipped with this type of supercharger is called an **altitude engine**. [Figure 5-11]

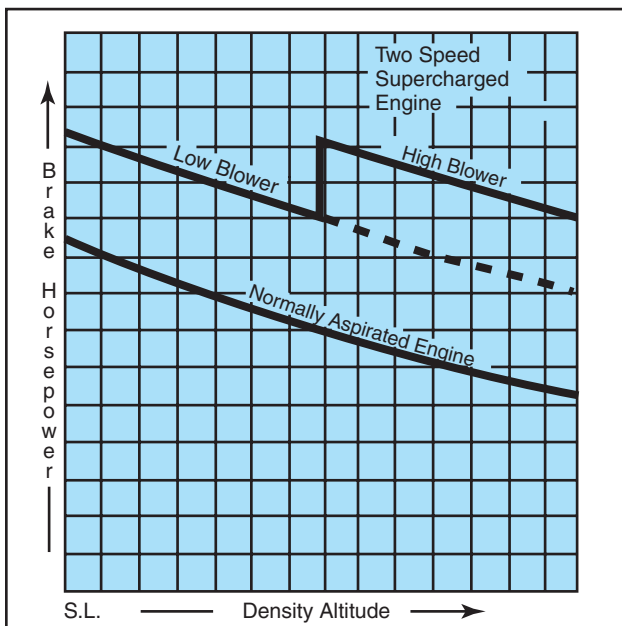

**Figure 5-11.** Power output of normally aspirated engine compared to a single-stage, two-speed supercharged engine.

### TURBOSUPERCHARGERS

The most efficient method of increasing horsepower in a reciprocating engine is by use of a turbosupercharger, or **turbocharger**, as it is usually called. A drawback of gear-driven superchargers is that they use a large amount of the engine's power output for the amount of power increase they produce. This problem is avoided with a turbocharger, because turbochargers are powered by an engine's exhaust gases. This means a turbocharger recovers energy from hot exhaust gases that would otherwise be lost.

Another advantage of turbochargers is that they can be controlled to maintain an engine's rated sea-level horsepower from sea level up to the engine's critical altitude. Critical altitude is the maximum altitude at which a turbocharged engine can produce its rated horsepower. Above the critical altitude, power output begins to decrease like it does for a normally aspirated engine.

Turbochargers increase the pressure of the engine's induction air, which allows the engine to develop sea level or greater horsepower at higher altitudes. A turbocharger is comprised of two main elements—a

**Altitude Engine**—A reciprocating aircraft engine having a rated takeoff power that is producible from sea level to an established higher altitude.

**Turbocharger**—An air compressor driven by exhaust gases, which increases the pressure of the air going into the engine through the carburetor or fuel injection system.

turbine and a compressor. The compressor section houses an impeller that turns at a high rate of speed. As induction air is drawn across the impeller blades, the impeller accelerates the air, allowing a large volume of air to be drawn into the compressor housing. The impeller's action subsequently produces high-pressure, high-density air, which is delivered to the engine. To turn the impeller, the engine's exhaust gases are used to drive a turbine wheel that is mounted on the opposite end of the impeller's drive shaft. By directing different amounts of exhaust gases to flow over the turbine, more energy can be extracted, causing the impeller to deliver more compressed air to the engine. The **waste gate** is used to vary the mass of exhaust gas flowing into the turbine. A waste gate is essentially an adjustable butterfly valve that is installed in the exhaust system. When closed, most of the exhaust gases from the engine are forced to flow through the turbine. When open, the exhaust gases are allowed to bypass the turbine by flowing directly out through the engine's exhaust pipe. [Figure 5-12]

Since the temperature of a gas rises when it is compressed, turbocharging causes the temperature of the induction air to increase. To reduce this temperature and lower the risk of detonation, many turbocharged engines use an intercooler. An **intercooler** is a small heat exchanger that uses outside air to cool the hot compressed air before it enters the fuel metering device.

### SYSTEM OPERATION

On most modern turbocharged engines, the position of the waste gate is governed by a pressure-sensing control mechanism coupled to an actuator. Engine oil directed into or away from this actuator moves the waste gate position. On these systems, the actuator is automatically positioned to produce the desired MAP simply by changing the position of the throttle control.

Other turbocharging system designs use a separate manual control to position the waste gate. With manual control, you must closely monitor the manifold pressure gauge to determine when the desired MAP has been achieved. Manual systems are often found on aircraft that have been modified with aftermarket turbocharging systems. These systems require special operating considerations. For example, if the waste gate is left closed after descending from a high altitude, it is possible to produce a manifold pressure that exceeds the engine's limitations. This condition is

**Waste Gate**—A controllable valve in the exhaust system of a reciprocating engine equipped with a turbocharger. The valve is controlled to vary the amount of exhaust gases forced through the turbocharger turbine.

**Intercooler**—A device used to remove heat from air or liquid.

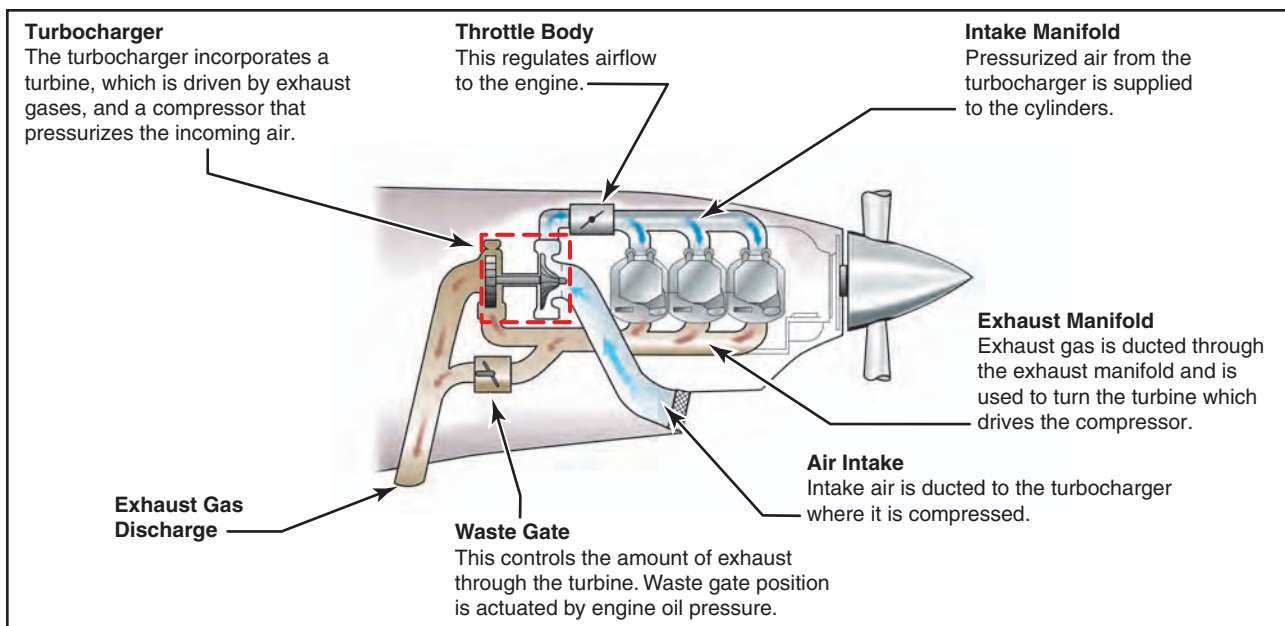

Figure 5-12. Turbocharger components.

referred to as an **overboost**, and it may produce severe detonation because of the leaning effect resulting from increased air density during descent.

Although an automatic waste gate system is less likely to experience an overboost condition, it can still occur. If you try to apply takeoff power while the engine oil temperature is below its normal operating range, the cold oil may not flow out of the waste gate actuator quickly enough to prevent an overboost. To help prevent overboosting, you should advance the throttle cautiously to prevent exceeding the maximum manifold pressure limits.

There are system limitations that you should be aware of when flying an aircraft with a turbocharger. For instance, a turbocharger turbine and impeller can operate at rotational speeds in excess of 80,000 r.p.m. while at extremely high temperatures. To achieve high rotational speed, the bearings within the system must be constantly supplied with engine oil to reduce the frictional forces and high temperature. To obtain adequate lubrication, the oil temperature should be in the normal operating range before high throttle settings are applied. In addition, you should allow the turbocharger to cool and the turbine to slow down before shutting the engine down. Otherwise, the oil remaining in the bearing housing will boil, causing hard carbon deposits to form on the bearings and shaft. These deposits rapidly deteriorate the turbocharger's efficiency and service life. For further limitations, refer to the AFM/POH.

**Overboost**—A condition in which a reciprocating engine has exceeded the maximum manifold pressure allowed by the manufacturer.

### HIGH ALTITUDE PERFORMANCE

As an aircraft equipped with a turbocharging system climbs, the waste gate is gradually closed to maintain the maximum allowable manifold pressure. At some point, however, the waste gate will be fully closed, and with further increases in altitude, the manifold pressure will begin to decrease. This is the critical altitude, which is established by the airplane or engine manufacturer. When evaluating the performance of the turbocharging system, if the manifold pressure begins decreasing before the specified critical altitude, the engine and turbocharging system should be inspected by a qualified aviation maintenance technician to verify the system's proper operation.

### IGNITION SYSTEM

The ignition system provides the spark that ignites the fuel/air mixture in the cylinders and is made up of magnetos, spark plugs, high-tension leads, and the ignition switch. [Figure 5-13]

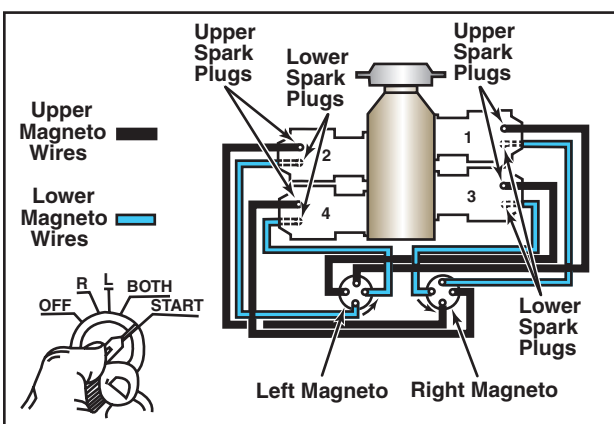

Figure 5-13. Ignition system components.

A **magneto** uses a permanent magnet to generate an electrical current completely independent of the aircraft's electrical system. The magneto generates sufficiently high voltage to jump a spark across the spark plug gap in each cylinder. The system begins to fire when you engage the starter and the crankshaft begins to turn. It continues to operate whenever the crankshaft is rotating.

Most standard certificated airplanes incorporate a dual ignition system with two individual magnetos, separate sets of wires, and spark plugs to increase reliability of the ignition system. Each magneto operates independently to fire one of the two spark plugs in each cylinder. The firing of two spark plugs improves combustion of the fuel/air mixture and results in a slightly higher power output. If one of the magnetos fails, the other is unaffected. The engine will continue to operate normally, although you can expect a slight decrease in engine power. The same is true if one of the two spark plugs in a cylinder fails.

The operation of the magneto is controlled in the cockpit by the ignition switch. The switch has five positions:

1. OFF
2. R—Right
3. L—Left
4. BOTH
5. START

With RIGHT or LEFT selected, only the associated magneto is activated. The system operates on both magnetos with BOTH selected.

You can identify a malfunctioning ignition system during the pretakeoff check by observing the decrease in r.p.m. that occurs when you first move the ignition switch from BOTH to RIGHT, and then from BOTH to LEFT. A small decrease in engine r.p.m. is normal during this check. The permissible decrease is listed in the AFM or POH. If the engine stops running when you switch to one magneto or if the r.p.m. drop exceeds the allowable limit, do not fly the airplane until the problem is corrected. The cause could be fouled plugs, broken or shorted wires between the magneto and the plugs, or improperly timed firing of the plugs. It should be noted that “no drop” in r.p.m. is not normal, and in that instance, the airplane should not be flown.

**Magneto**—A self-contained, engine-driven unit that supplies electrical current to the spark plugs; completely independent of the airplane's electrical system. Normally, there are two magnetos per engine.

Following engine shutdown, turn the ignition switch to the OFF position. Even with the battery and master switches OFF, the engine can fire and turn over if you leave the ignition switch ON and the propeller is moved because the magneto requires no outside source of electrical power. The potential for serious injury in this situation is obvious.

Loose or broken wires in the ignition system also can cause problems. For example, if the ignition switch is OFF, the magneto may continue to fire if the ignition switch ground wire is disconnected. If this occurs, the only way to stop the engine is to move the mixture lever to the idle cutoff position, then have the system checked by a qualified aviation maintenance technician.

## COMBUSTION

During normal combustion, the fuel/air mixture burns in a very controlled and predictable manner. Although the process occurs in a fraction of a second, the mixture actually begins to burn at the point where it is ignited by the spark plugs, then burns away from the plugs until it is all consumed. This type of combustion causes a smooth buildup of temperature and pressure and ensures that the expanding gases deliver the maximum force to the piston at exactly the right time in the power stroke. [Figure 5-14]

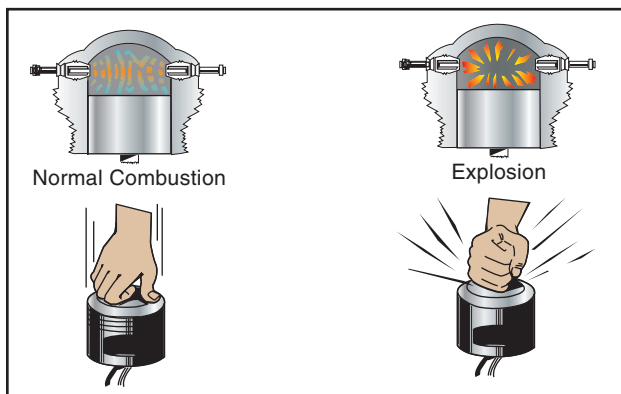

Figure 5-14. Normal combustion and explosive combustion.

**Detonation** is an uncontrolled, explosive ignition of the fuel/air mixture within the cylinder's combustion chamber. It causes excessive temperatures and pressures which, if not corrected, can quickly lead to failure of the piston, cylinder, or valves. In less severe cases, detonation causes engine overheating, roughness, or loss of power.

Detonation is characterized by high cylinder head temperatures, and is most likely to occur when operating at high power settings. Some common operational causes of detonation include:

**Detonation**—An uncontrolled, explosive ignition of the fuel/air mixture within the cylinder's combustion chamber.



- Using a lower fuel grade than that specified by the aircraft manufacturer.
- Operating with extremely high manifold pressures in conjunction with low r.p.m.
- Operating the engine at high power settings with an excessively lean mixture.
- Detonation also can be caused by extended ground operations, or steep climbs where cylinder cooling is reduced.

Detonation may be avoided by following these basic guidelines during the various phases of ground and flight operations:

- Make sure the proper grade of fuel is being used.
- While on the ground, keep the cowl flaps (if available) in the full-open position to provide the maximum airflow through the cowling.
- During takeoff and initial climb, the onset of detonation can be reduced by using an enriched fuel mixture, as well as using a shallower climb angle to increase cylinder cooling.
- Avoid extended, high power, steep climbs.
- Develop a habit of monitoring the engine instruments to verify proper operation according to procedures established by the manufacturer.

**Preignition** occurs when the fuel/air mixture ignites prior to the engine's normal ignition event. Premature burning is usually caused by a residual hot spot in the combustion chamber, often created by a small carbon deposit on a spark plug, a cracked spark plug insulator, or other damage in the cylinder that causes a part to heat sufficiently to ignite the fuel/air charge. Preignition causes the engine to lose power, and produces high operating temperature. As with detonation, preignition may also cause severe engine damage, because the expanding gases exert excessive pressure on the piston while still on its compression stroke.

Detonation and preignition often occur simultaneously and one may cause the other. Since either condition causes high engine temperature accompanied by a decrease in engine performance, it is often difficult to distinguish between the two. Using the recommended grade of fuel and operating the engine within its proper temperature, pressure, and r.p.m. ranges reduce the chance of detonation or preignition.

**Preignition**—The uncontrolled combustion of the fuel/air mixture in advance of the normal ignition.

## FUEL SYSTEMS

The fuel system is designed to provide an uninterrupted flow of clean fuel from the fuel tanks to the engine. The fuel must be available to the engine under all conditions of engine power, altitude, attitude, and during all approved flight maneuvers. Two common classifications apply to fuel systems in small airplanes—gravity-feed and fuel-pump systems.

The gravity-feed system utilizes the force of gravity to transfer the fuel from the tanks to the engine—for example, on high-wing airplanes where the fuel tanks are installed in the wings. This places the fuel tanks above the carburetor, and the fuel is gravity fed through the system and into the carburetor. If the design of the airplane is such that gravity cannot be used to transfer fuel, fuel pumps are installed—for example, on low-wing airplanes where the fuel tanks in the wings are located below the carburetor. [Figure 5-15]

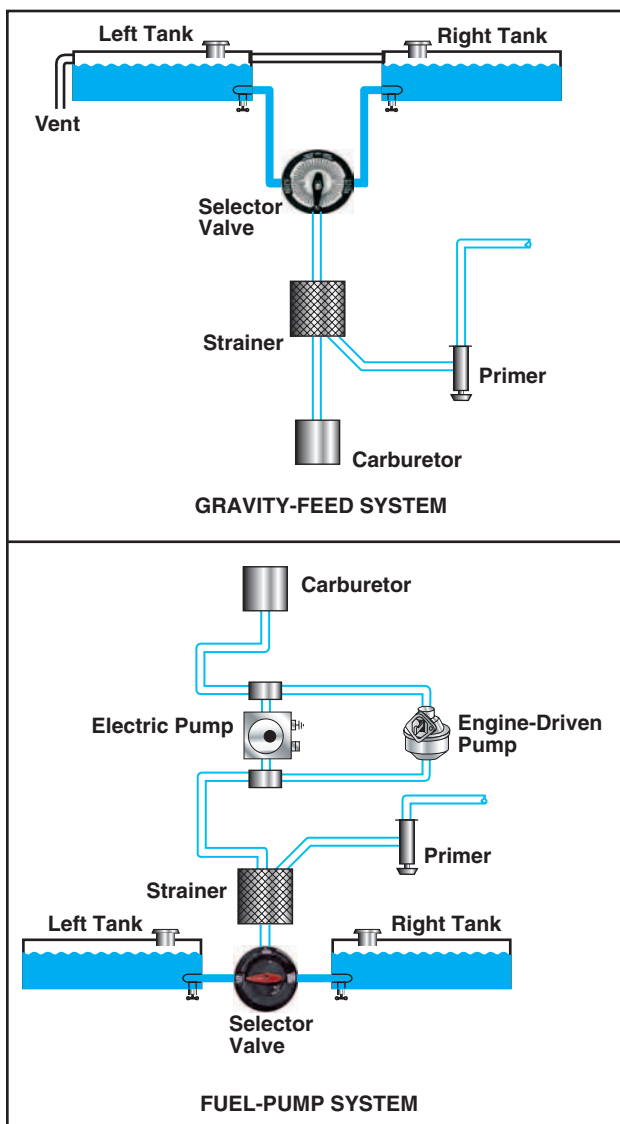

Figure 5-15. Gravity-feed and fuel-pump systems.

## FUEL PUMPS

Airplanes with fuel pump systems have two fuel pumps. The main pump system is engine driven, and an electrically driven auxiliary pump is provided for use in engine starting and in the event the engine pump fails. The auxiliary pump, also known as a boost pump, provides added reliability to the fuel system. The electrically driven auxiliary pump is controlled by a switch in the cockpit.

## FUEL PRIMER

Both gravity fed and pump systems may incorporate a fuel primer into the system. The primer is used to draw fuel from the tanks to vaporize it directly into the cylinders prior to starting the engine. This is particularly helpful during cold weather, when engines are hard to start because there is not enough heat available to vaporize the fuel in the carburetor. It is important to lock the primer in place when it is not in use. If the knob is free to move, it may vibrate out during flight and can cause an excessively rich mixture. To avoid overpriming, read the priming instructions for your airplane.

## FUEL TANKS

The fuel tanks, normally located inside the wings of an airplane, have a filler opening on top of the wing through which they can be filled. A filler cap covers this opening. The tanks are vented to the outside to maintain atmospheric pressure inside the tank. They may be vented through the filler cap or through a tube extending through the surface of the wing. Fuel tanks also include an overflow drain that may stand alone or be collocated with the fuel tank vent. This allows fuel to expand with increases in temperature without damage to the tank itself. If the tanks have been filled on a hot day, it is not unusual to see fuel coming from the overflow drain.

## FUEL GAUGES

The fuel quantity gauges indicate the amount of fuel measured by a sensing unit in each fuel tank and is displayed in gallons or pounds. Aircraft certification rules only require accuracy in fuel gauges when they read “empty.” Any reading other than “empty” should be verified. Do not depend solely on the accuracy of the fuel quantity gauges. Always visually check the fuel level in each tank during the preflight inspection, and then compare it with the corresponding fuel quantity indication.

If a fuel pump is installed in the fuel system, a fuel pressure gauge is also included. This gauge indicates the pressure in the fuel lines. The normal operating pressure can be found in the AFM/POH, or on the gauge by color coding.

## FUEL SELECTORS

The fuel selector valve allows selection of fuel from various tanks. A common type of selector valve contains four positions: LEFT, RIGHT, BOTH, and OFF. Selecting the LEFT or RIGHT position allows fuel to feed only from that tank, while selecting the BOTH position feeds fuel from both tanks. The LEFT or RIGHT position may be used to balance the amount of fuel remaining in each wing tank. [Figure 5-16]



Figure 5-16. Fuel selector valve.

Fuel placards will show any limitations on fuel tank usage, such as “level flight only” and/or “both” for landings and takeoffs.

Regardless of the type of fuel selector in use, fuel consumption should be monitored closely to ensure that a tank does not run completely out of fuel. Running a fuel tank dry will not only cause the engine to stop, but running for prolonged periods on one tank causes an unbalanced fuel load between tanks. Running a tank completely dry may allow air to enter the fuel system, which may cause vapor lock. When this situation develops, it may be difficult to restart the engine. On fuel-injected engines, the fuel may become so hot it vaporizes in the fuel line, not allowing fuel to reach the cylinders.

## FUEL STRAINERS, SUMPS, AND DRAINS

After the fuel selector valve, the fuel passes through a strainer before it enters the carburetor. This strainer removes moisture and other sediments that might be in the system. Since these contaminants are heavier than aviation fuel, they settle in a sump at the bottom of the strainer assembly. A sump is defined as a low point in a fuel system and/or fuel tank. The fuel system may contain sump, fuel strainer, and fuel tank drains, some of which may be collocated.

The fuel strainer should be drained before each flight. Fuel samples should be drained and checked visually

for water and contaminants. Water in the sump is hazardous because in cold weather the water can freeze and block fuel lines. In warm weather, it can flow into the carburetor and stop the engine. If water is present in the sump, it is likely there is more water in the fuel tanks, and you should continue to drain them until there is no evidence of water. In any event, never take off until you are certain that all water and contaminants have been removed from the engine fuel system.

Because of the variation in fuel systems, you should become thoroughly familiar with the systems that apply to your airplane. Consult the AFM or POH for specific operating procedures.

### FUEL GRADES

Aviation gasoline, or AVGAS, is identified by an octane or performance number (grade), which designates the antiknock value or knock resistance of the fuel mixture in the engine cylinder. The higher the grade of gasoline, the more pressure the fuel can withstand without detonating. Lower grades of fuel are used in lower-compression engines because these fuels ignite at a lower temperature. Higher grades are used in higher-compression engines, because they must ignite at higher temperatures, but not prematurely. If the proper grade of fuel is not available, use the next higher grade as a substitute. Never use a lower grade. This can cause the cylinder head temperature and engine oil temperature to exceed their normal operating range, which may result in detonation.

Several grades of aviation fuel are available. Care must be exercised to ensure that the correct aviation grade is being used for the specific type of engine. The proper fuel grade is stated in the AFM or POH, on placards in the cockpit, and next to the filler caps. Due to its lead content, auto gas should NEVER be used in aircraft engines unless the aircraft has been modified with a Supplemental Type Certificate (STC) issued by the Federal Aviation Administration.

The current method to identify aviation gasoline for aircraft with reciprocating engines is by the octane and performance number, along with the abbreviation AVGAS. These aircraft use AVGAS 80, 100, and 100LL. Although AVGAS 100LL performs the same as grade 100, the “LL” indicates it has a low lead content. Fuel for aircraft with turbine engines is classified as JET A, JET A-1, and JET B. Jet fuel is basically kerosene and has a distinctive kerosene smell.

Since use of the correct fuel is critical, dyes are added to help identify the type and grade of fuel. [Figure 5-17]





FUEL TYPE AND GRADE	COLOR OF FUEL	EQUIPMENT COLOR
AVGAS 80	RED	
AVGAS 100	GREEN	
AVGAS 100LL	BLUE	
JET A	COLORLESS OR STRAW	

Figure 5-17. Aviation fuel color-coding system.

In addition to the color of the fuel itself, the color-coding system extends to decals and various airport fuel handling equipment. For example, all aviation gasolines are identified by name, using white letters on a red background. In contrast, turbine fuels are identified by white letters on a black background.

### FUEL CONTAMINATION

Of the accidents attributed to powerplant failure from fuel contamination, most have been traced to:

- Inadequate preflight inspection by the pilot.
- Servicing aircraft with improperly filtered fuel from small tanks or drums.
- Storing aircraft with partially filled fuel tanks.
- Lack of proper maintenance.

Fuel should be drained from the fuel strainer quick drain and from each fuel tank sump into a transparent container, and then checked for dirt and water. When the fuel strainer is being drained, water in the tank may not appear until all the fuel has been drained from the lines leading to the tank. This indicates that water remains in the tank, and is not forcing the fuel out of the fuel lines leading to the fuel strainer. Therefore, drain enough fuel from the fuel strainer to be certain that fuel is being drained from the tank. The amount will depend on the length of fuel line from the tank to the drain. If water or other contaminants are found in the first sample, drain further samples until no trace appears.

Water may also remain in the fuel tanks after the drainage from the fuel strainer had ceased to show any trace of water. This residual water can be removed only by draining the fuel tank sump drains.

Water is the principal fuel contaminant. Suspended water droplets in the fuel can be identified by a cloudy appearance of the fuel or by the clear separation of water from the colored fuel, which occurs after the water has settled to the bottom of the tank. As a safety measure, the fuel sumps should be drained before every flight during the preflight inspection.

Fuel tanks should be filled after each flight, or at least after the last flight of the day to prevent moisture condensation within the tank. Another way to prevent fuel contamination is to avoid refueling from cans and drums. Refueling from cans or drums may result in fuel contamination.

The use of a funnel and chamois skin when refueling from cans or drums is hazardous under any conditions, and should be discouraged. In remote areas or in emergency situations, there may be no alternative to refueling from sources with inadequate anticontamination systems, and a chamois and funnel may be the only possible means of filtering fuel. However, the use of a chamois will not always ensure decontaminated fuel. Worn-out chamois will not filter water; neither will a new, clean chamois that is already water-wet or damp. Most imitation chamois skins will not filter water.

### REFUELING PROCEDURES

Static electricity is formed by the friction of air passing over the surfaces of an airplane in flight and by the flow of fuel through the hose and nozzle during refueling. Nylon, dacron, or wool clothing is especially prone to accumulate and discharge static electricity from the person to the funnel or nozzle. To guard against the possibility of static electricity igniting fuel fumes, a ground wire should be attached to the aircraft before the fuel cap is removed from the tank. The refueling nozzle then should be grounded to the aircraft before refueling is begun, and should remain grounded throughout the refueling process. When a fuel truck is used, it should be grounded prior to the fuel nozzle contacting the aircraft.

If fueling from drums or cans is necessary, proper bonding and grounding connections are important. Drums should be placed near grounding posts, and the following sequence of connections observed:

1. Drum to ground.
2. Ground to aircraft.
3. Drum to aircraft.

4. Nozzle to aircraft before the fuel cap is removed.

When disconnecting, reverse the order.

The passage of fuel through a chamois increases the charge of static electricity and the danger of sparks. The aircraft must be properly grounded and the nozzle, chamois filter, and funnel bonded to the aircraft. If a can is used, it should be connected to either the grounding post or the funnel. Under no circumstances should a plastic bucket or similar nonconductive container be used in this operation.

### STARTING SYSTEM

Most small aircraft use a direct-cranking electric starter system. This system consists of a source of electricity, wiring, switches, and solenoids to operate the starter and a starter motor. Most aircraft have starters that automatically engage and disengage when operated, but some older aircraft have starters that are mechanically engaged by a lever actuated by the pilot. The starter engages the aircraft flywheel, rotating the engine at a speed that allows the engine to start and maintain operation.

Electrical power for starting is usually supplied by an on-board battery, but can also be supplied by external power through an external power receptacle. When the battery switch is turned on, electricity is supplied to the main power bus through the battery solenoid. Both the starter and the starter switch draw current from the main bus, but the starter will not operate until the starting solenoid is energized by the starter switch being turned to the "start" position. When the starter switch is released from the "start" position, the solenoid removes power from the starter motor. The starter motor is protected from being driven by the engine through a clutch in the starter drive that allows the engine to run faster than the starter motor. [Figure 5-18]

When starting an engine, the rules of safety and courtesy should be strictly observed. One of the most important is to make sure there is no one near the propeller. In addition, the wheels should be chocked and the brakes set, to avoid hazards caused by unintentional movement. To avoid damage to the propeller and property, the airplane should be in an area where the propeller will not stir up gravel or dust.

### OIL SYSTEMS

The engine oil system performs several important functions, including:

- Lubrication of the engine's moving parts.
- Cooling of the engine by reducing friction.
- Removing heat from the cylinders.



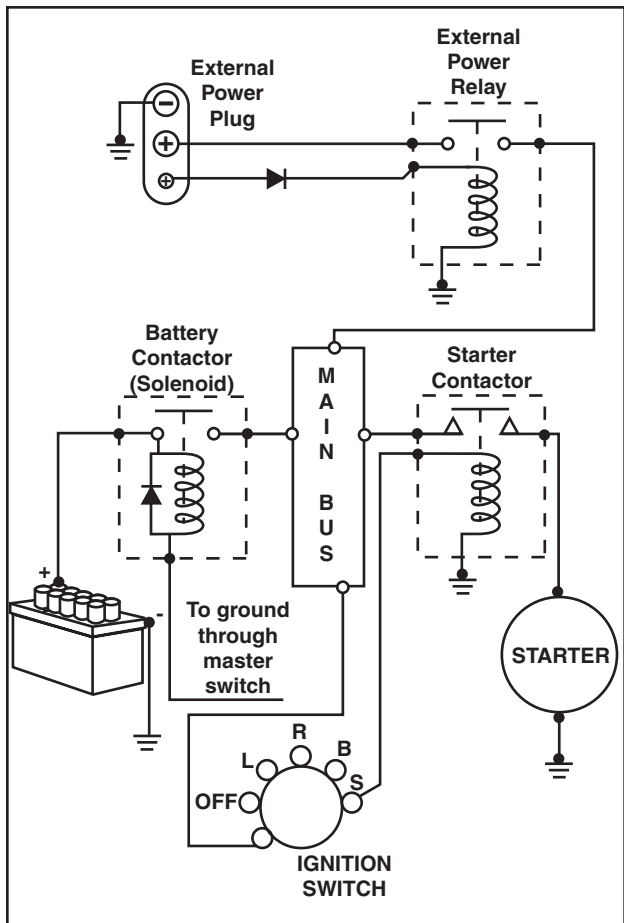
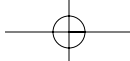

Figure 5-18. Typical starting circuit.

- Providing a seal between the cylinder walls and pistons.
- Carrying away contaminants.

Reciprocating engines use either a wet-sump or dry-sump oil system. In a dry-sump system, the oil is contained in a separate tank, and circulated through the engine by pumps. In a wet-sump system, the oil is located in a sump, which is an integral part of the engine. [Figure 5-19]

The main component of a wet-sump system is the oil pump, which draws oil from the sump and routes it to the engine. After the oil passes through the engine, it returns to the sump. In some engines, additional lubrication is supplied by the rotating crankshaft, which splashes oil onto portions of the engine.

An oil pump also supplies oil pressure in a dry-sump system, but the source of the oil is a separate oil tank, located external to the engine. After oil is routed through the engine, it is pumped from the various locations in the engine back to the oil tank by scavenge pumps. Dry sump systems allow for a greater volume of oil to be supplied to the engine, which makes them more suitable for very large reciprocating engines.

The oil pressure gauge provides a direct indication of the oil system operation. It measures the pressure in

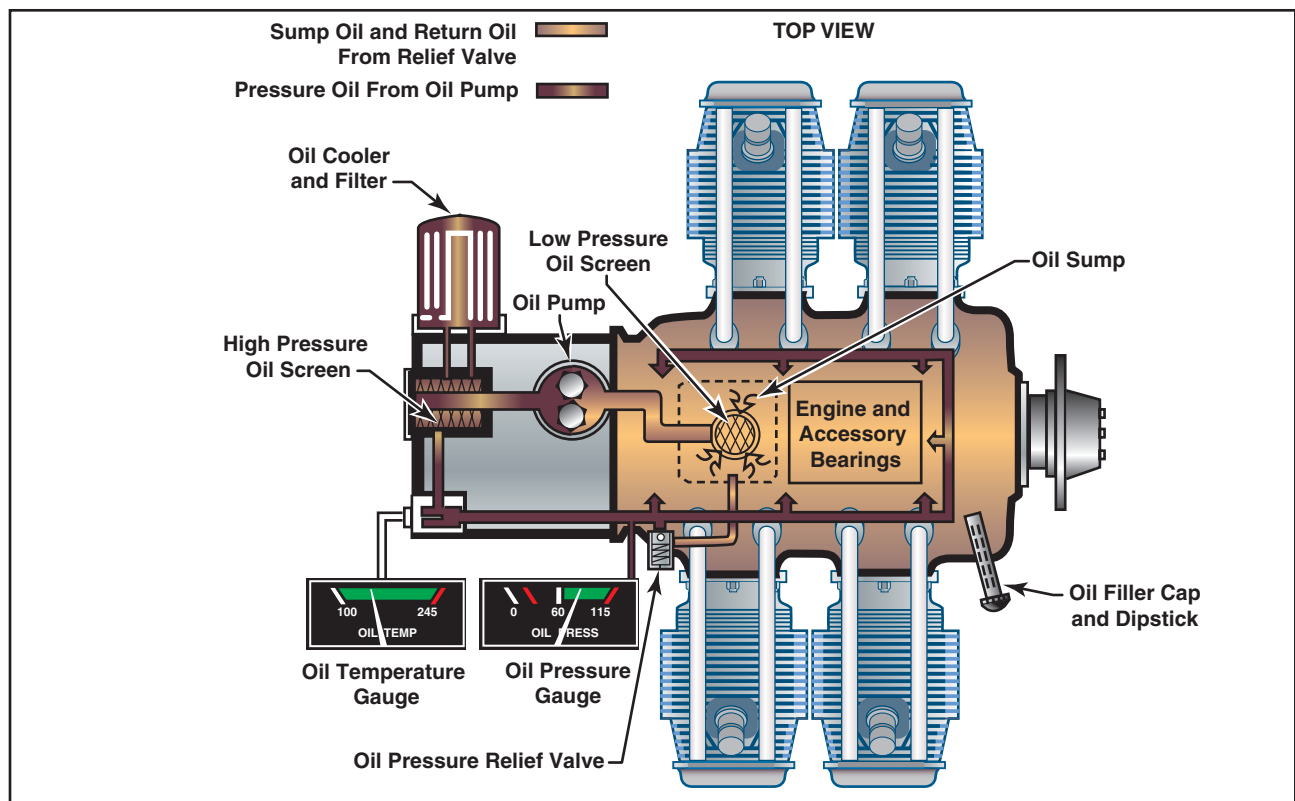
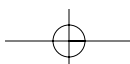

Figure 5-19. Wet-sump oil system.



pounds per square inch (p.s.i.) of the oil supplied to the engine. Green indicates the normal operating range, while red indicates the minimum and maximum pressures. There should be an indication of oil pressure during engine start. Refer to the AFM/POH for manufacturer limitations.

The oil temperature gauge measures the temperature of oil. A green area shows the normal operating range and the red line indicates the maximum allowable temperature. Unlike oil pressure, changes in oil temperature occur more slowly. This is particularly noticeable after starting a cold engine, when it may take several minutes or longer for the gauge to show any increase in oil temperature.

Check oil temperature periodically during flight especially when operating in high or low ambient air temperature. High temperature indications may indicate a plugged oil line, a low oil quantity, a blocked oil cooler, or a defective temperature gauge. Low temperature indications may indicate improper oil viscosity during cold weather operations.

The oil filler cap and dipstick (for measuring the oil quantity) are usually accessible through a panel in the engine cowling. If the quantity does not meet the manufacturer's recommended operating levels, oil should be added. The AFM, POH, or placards near the access panel provide information about the correct oil type and weight, as well as the minimum and maximum oil quantity. [Figure 5-20]



**Figure 5-20.** Always check the engine oil level during the pre-flight inspection.

## ENGINE COOLING SYSTEMS

The burning fuel within the cylinders produces intense heat, most of which is expelled through the exhaust system. Much of the remaining heat, however, must be removed, or at least dissipated, to prevent the engine from overheating. Otherwise, the extremely high engine temperatures can lead to loss of power, excessive oil consumption, detonation, and serious engine damage.

While the oil system is vital to internal cooling of the engine, an additional method of cooling is necessary for the engine's external surface. Most small airplanes are air cooled, although some are liquid cooled.

Air cooling is accomplished by air flowing into the engine compartment through openings in front of the engine cowling. Baffles route this air over fins attached to the engine cylinders, and other parts of the engine, where the air absorbs the engine heat. Expulsion of the hot air takes place through one or more openings in the lower, aft portion of the engine cowling. [Figure 5-21]

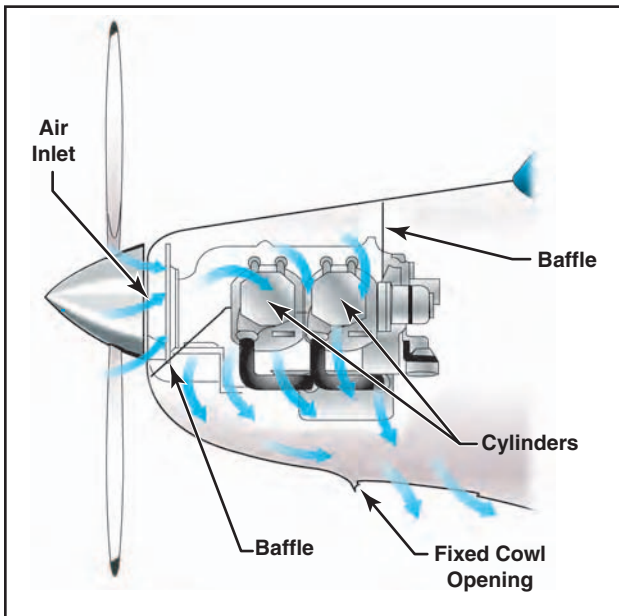

**Figure 5-21.** Outside air aids in cooling the engine.

The outside air enters the engine compartment through an inlet behind the propeller hub. Baffles direct it to the hottest parts of the engine, primarily the cylinders, which have fins that increase the area exposed to the airflow.

The air cooling system is less effective during ground operations, takeoffs, go-arounds, and other periods of high-power, low-air-speed operation. Conversely, high-speed descents provide excess air and can shock-cool the engine, subjecting it to abrupt temperature fluctuations.

Operating the engine at higher than its designed temperature can cause loss of power, excessive oil consumption, and detonation. It will also lead to serious permanent damage, such as scoring the cylinder walls, damaging the pistons and rings, and burning and warping the valves. Monitoring the cockpit engine temperature instruments will aid in avoiding high operating temperature.

Under normal operating conditions in airplanes not equipped with cowl flaps, the engine temperature can be controlled by changing the airspeed or the power output of the engine. High engine temperatures can be decreased by increasing the airspeed and/or reducing the power.

The oil temperature gauge gives an indirect and delayed indication of rising engine temperature, but can be used for determining engine temperature if this is the only means available.

Many airplanes are equipped with a cylinder-head temperature gauge. This instrument indicates a direct and immediate cylinder temperature change. This instrument is calibrated in degrees Celsius or Fahrenheit, and is usually color-coded with a green arc to indicate the normal operating range. A red line on the instrument indicates maximum allowable cylinder head temperature.

To avoid excessive cylinder head temperatures, increase airspeed, enrich the mixture, and/or reduce power. Any of these procedures help in reducing the engine temperature. On airplanes equipped with **cowl flaps**, use the cowl flap positions to control the temperature. Cowl flaps are hinged covers that fit over the opening through which the hot air is expelled. If the engine temperature is low, the cowl flaps can be closed, thereby restricting the flow of expelled hot air and increasing engine temperature. If the engine temperature is high, the cowl flaps can be opened to permit a greater flow of air through the system, thereby decreasing the engine temperature.

## EXHAUST SYSTEMS

Engine exhaust systems vent the burned combustion gases overboard, provide heat for the cabin, and defrost the windscreen. An exhaust system has exhaust piping attached to the cylinders, as well as a muffler and a muffler shroud. The exhaust gases are pushed out of the cylinder through the exhaust valve and then through the exhaust pipe system to the atmosphere.

**Cowl Flaps**—Shutter-like devices arranged around certain air-cooled engine cowlings, which may be opened or closed to regulate the flow of air around the engine.

For cabin heat, outside air is drawn into the air inlet and is ducted through a shroud around the muffler. The muffler is heated by the exiting exhaust gases and, in turn, heats the air around the muffler. This heated air is then ducted to the cabin for heat and defrost applications. The heat and defrost are controlled in the cockpit, and can be adjusted to the desired level.

Exhaust gases contain large amounts of carbon monoxide, which is odorless and colorless. Carbon monoxide is deadly, and its presence is virtually impossible to detect. The exhaust system must be in good condition and free of cracks.

Some exhaust systems have an exhaust gas temperature probe. This probe transmits the exhaust gas temperature (EGT) to an instrument in the cockpit. The EGT gauge measures the temperature of the gases at the exhaust manifold. This temperature varies with the ratio of fuel to air entering the cylinders and can be used as a basis for regulating the fuel/air mixture. The EGT gauge is highly accurate in indicating the correct mixture setting. When using the EGT to aid in leaning the fuel/air mixture, fuel consumption can be reduced. For specific procedures, refer to the manufacturer's recommendations for leaning the mixture.

## ELECTRICAL SYSTEM

Airplanes are equipped with either a 14- or 28-volt direct-current electrical system. A basic airplane electrical system consists of the following components:

- Alternator/generator
- Battery
- Master/battery switch
- Alternator/generator switch
- Bus bar, fuses, and circuit breakers
- Voltage regulator
- Ammeter/loadmeter
- Associated electrical wiring

Engine-driven alternators or generators supply electric current to the electrical system. They also maintain a sufficient electrical charge in the battery. Electrical energy stored in a battery provides a source of electrical power for starting the engine and a limited supply of electrical power for use in the event the alternator or generator fails.

Most direct current generators will not produce a sufficient amount of electrical current at low engine r.p.m. to operate the entire electrical system. Therefore, during operations at low engine r.p.m., the electrical needs must be drawn from the battery, which can quickly be depleted.

Alternators have several advantages over generators. Alternators produce sufficient current to operate the entire electrical system, even at slower engine speeds, by producing alternating current, which is converted to direct current. The electrical output of an alternator is more constant throughout a wide range of engine speeds.

Some airplanes have receptacles to which an external ground power unit (GPU) may be connected to provide electrical energy for starting. These are very useful, especially during cold weather starting. Follow the manufacturer's recommendations for engine starting using a GPU.

The electrical system is turned on or off with a master switch. Turning the master switch to the ON position provides electrical energy to all the electrical equipment circuits with the exception of the ignition system. Equipment that commonly uses the electrical system for its source of energy includes:

- Position lights
- Anticollision lights
- Landing lights
- Taxi lights
- Interior cabin lights
- Instrument lights
- Radio equipment
- Turn indicator
- Fuel gauges
- Electric fuel pump
- Stall warning system
- Pitot heat
- Starting motor

Many airplanes are equipped with a battery switch that controls the electrical power to the airplane in a manner similar to the master switch. In addition, an alternator switch is installed which permits the pilot to exclude the alternator from the electrical system in the event of alternator failure. [Figure 5-22]



**Figure 5-22.** On this master switch, the left half is for the alternator and the right half is for the battery.

With the alternator half of the switch in the OFF position, the entire electrical load is placed on the battery. Therefore, all nonessential electrical equipment should be turned off to conserve battery power.

A bus bar is used as a terminal in the airplane electrical system to connect the main electrical system to the equipment using electricity as a source of power. This simplifies the wiring system and provides a common point from which voltage can be distributed throughout the system. [Figure 5-23]

Fuses or circuit breakers are used in the electrical system to protect the circuits and equipment from electrical overload. Spare fuses of the proper amperage limit should be carried in the airplane to replace defective or blown fuses. Circuit breakers have the same function as a fuse but can be manually reset, rather than replaced, if an overload condition occurs in the electrical system. Placards at the fuse or circuit breaker panel identify the circuit by name and show the amperage limit.

An ammeter is used to monitor the performance of the airplane electrical system. The ammeter shows if the alternator/generator is producing an adequate supply of electrical power. It also indicates whether or not the battery is receiving an electrical charge.

Ammeters are designed with the zero point in the center of the face and a negative or positive indication on either side. [Figure 5-24] When the pointer of the ammeter on the left is on the plus side, it shows the charging rate of the battery. A minus indication means more current is being drawn from the battery than is being replaced. A full-scale minus deflection indicates a malfunction of the alternator/generator. A full-scale positive deflection indicates a malfunction of the regulator. In either case, consult the AFM or POH for appropriate action to be taken.



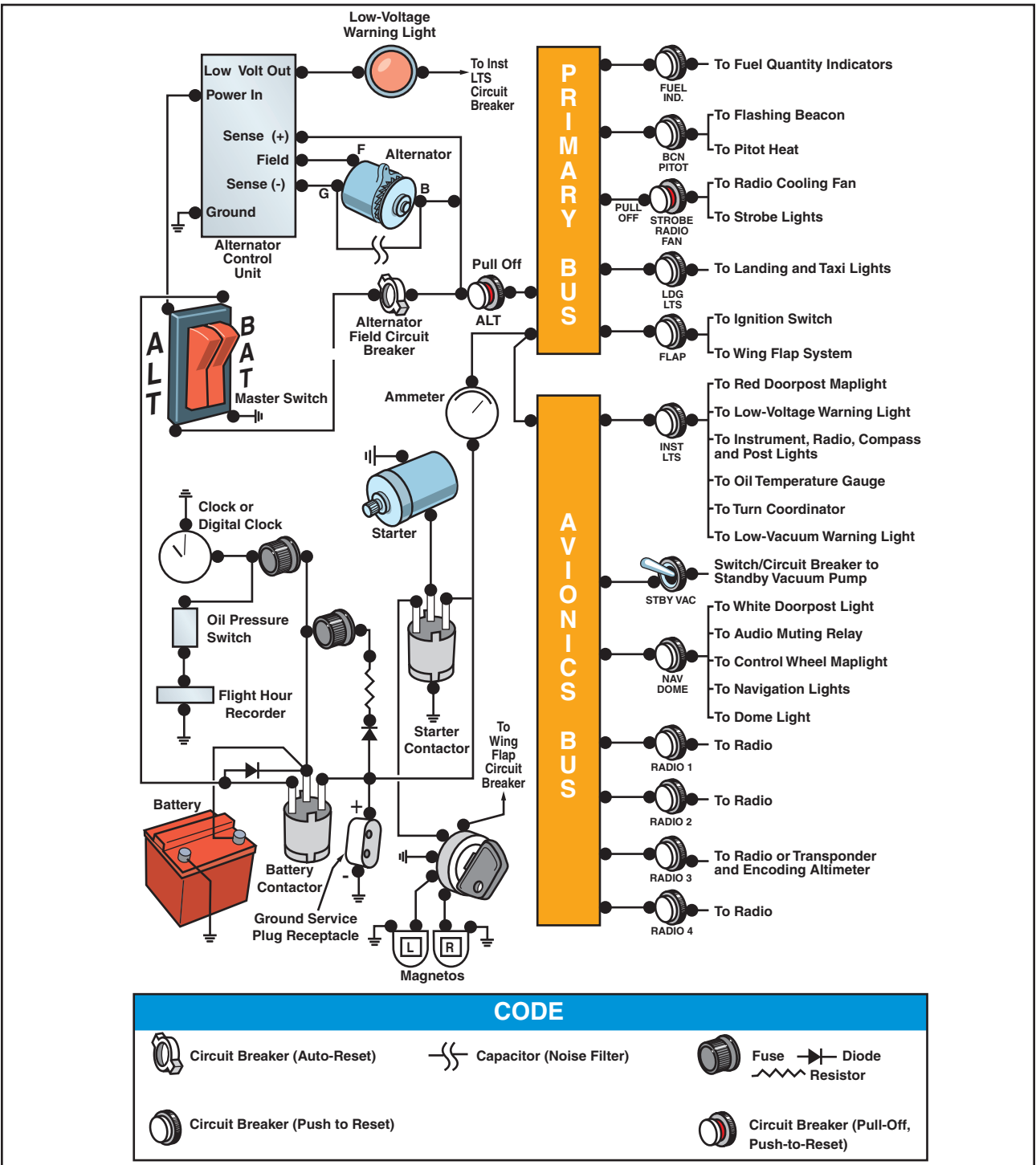

Figure 5-23. Electrical system schematic.

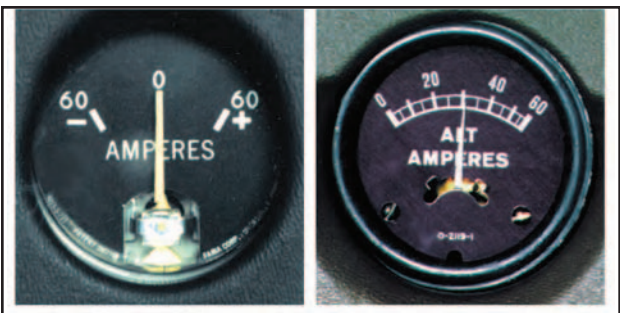

Figure 5-24. Ammeter and loadmeter.

Not all airplanes are equipped with an ammeter. Some have a warning light that, when lighted, indicates a discharge in the system as a generator/alternator malfunction. Refer to the AFM or POH for appropriate action to be taken.

Another electrical monitoring indicator is a loadmeter. This type of gauge, illustrated on the right in figure 5-24, has a scale beginning with zero and shows the load being placed on the alternator/generator. The loadmeter reflects the total percentage of the load placed on the

generating capacity of the electrical system by the electrical accessories and battery. When all electrical components are turned off, it reflects only the amount of charging current demanded by the battery.

A voltage regulator controls the rate of charge to the battery by stabilizing the generator or alternator electrical output. The generator/alternator voltage output should be higher than the battery voltage. For example, a 12-volt battery would be fed by a generator/alternator system of approximately 14 volts. The difference in voltage keeps the battery charged.

## HYDRAULIC SYSTEMS

There are multiple applications for hydraulic use in airplanes, depending on the complexity of the airplane. For example, hydraulics are often used on small airplanes to operate wheel brakes, retractable landing gear, and some constant-speed propellers. On large airplanes, hydraulics are used for flight control surfaces, wing flaps, spoilers, and other systems.

A basic hydraulic system consists of a reservoir, pump (either hand, electric, or engine driven), a filter to keep the fluid clean, selector valve to control the direction of flow, relief valve to relieve excess pressure, and an actuator.

The hydraulic fluid is pumped through the system to an actuator or **servo**. Servos can be either single-acting or double-acting servos based on the needs of the system. This means that the fluid can be applied to one or both sides of the servo, depending on the servo type, and therefore provides power in one direction with a single-acting servo. A servo is a cylinder with a piston inside that turns fluid power into work and creates the power needed to move an aircraft system or flight control. The selector valve allows the fluid direction to be controlled. This is necessary for operations like the extension and retraction of landing gear where the fluid must work in two different directions. The relief valve provides an outlet for the system in the event of excessive fluid pressure in the system. Each system incorporates different components to meet the individual needs of different aircraft.

A mineral-based fluid is the most widely used type for small airplanes. This type of hydraulic fluid, which is a kerosene-like petroleum product, has good lubricating properties, as well as additives to inhibit foaming and prevent the formation of corrosion. It is quite stable chemically, has very little viscosity change with temperature, and is dyed for identification. Since several types of hydraulic fluids are commonly used,

**Servo**—A motor or other form of actuator which receives a small signal from the control device and exerts a large force to accomplish the desired work.

make sure your airplane is serviced with the type specified by the manufacturer. Refer to the AFM, POH, or the Maintenance Manual. [Figure 5-25]

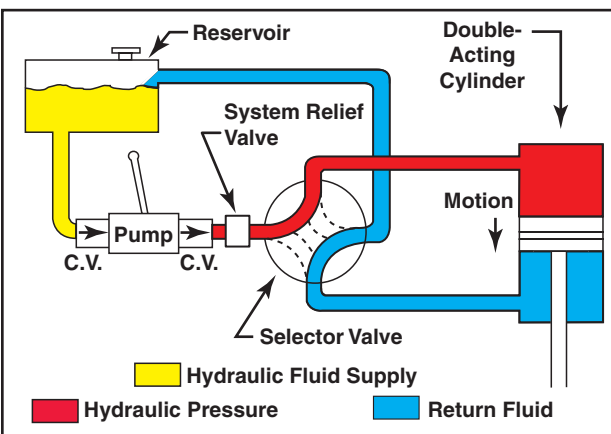

Figure 5-25. Basic hydraulic system.

## LANDING GEAR

The landing gear forms the principal support of the airplane on the surface. The most common type of landing gear consists of wheels, but airplanes can also be equipped with floats for water operations, or skis for landing on snow. [Figure 5-26]



Figure 5-26. The landing gear supports the airplane during the takeoff run, landing, taxiing, and when parked.

The landing gear on small airplanes consists of three wheels—two main wheels, one located on each side of the fuselage, and a third wheel, positioned either at the front or rear of the airplane. Landing gear employing a rear-mounted wheel is called a conventional landing gear. Airplanes with conventional landing gear are often referred to as tailwheel airplanes. When the third wheel is located on the nose, it is called a nosewheel, and the design is referred to as a tricycle gear. A steerable nosewheel or tailwheel permits the airplane to be controlled throughout all operations while on the ground.

## TRICYCLE LANDING GEAR AIRPLANES

A tricycle gear airplane has three main advantages:

1. It allows more forceful application of the brakes during landings at high speeds without resulting in the airplane nosing over.
2. It permits better forward visibility for the pilot during takeoff, landing, and taxiing.
3. It tends to prevent ground looping (swerving) by providing more directional stability during ground operation since the airplane's center of gravity (CG) is forward of the main wheels. The forward CG, therefore, tends to keep the airplane moving forward in a straight line rather than ground looping.

Nosewheels are either steerable or castering. Steerable nosewheels are linked to the rudders by cables or rods, while castering nosewheels are free to swivel. In both cases, you steer the airplane using the rudder pedals. However, airplanes with a castering nosewheel may require you to combine the use of the rudder pedals with independent use of the brakes.

#### **TAILWHEEL LANDING GEAR AIRPLANES**

On tailwheel airplanes, two main wheels, which are attached to the airframe ahead of its center of gravity, support most of the weight of the structure, while a tailwheel at the very back of the fuselage provides a third point of support. This arrangement allows adequate ground clearance for a larger propeller and is more desirable for operations on unimproved fields. [Figure 5-27]

The main drawback with the tailwheel landing gear is that the center of gravity is behind the main gear. This makes directional control more difficult while on the ground. If you allow the airplane to swerve while rolling on the ground at a speed below that at which the rudder has sufficient control, the center of gravity will attempt to get ahead of the main gear. This may cause the airplane to ground loop.



**Figure 5-27. Tailwheel landing gear.**

Another disadvantage for tailwheel airplanes is the lack of good forward visibility when the tailwheel is on or near the surface. Because of the associated hazards, specific training is required in tailwheel airplanes.

#### **FIXED AND RETRACTABLE LANDING GEAR**

Landing gear can also be classified as either fixed or retractable. A fixed gear always remains extended and has the advantage of simplicity combined with low maintenance. A retractable gear is designed to streamline the airplane by allowing the landing gear to be stowed inside the structure during cruising flight. [Figure 5-28]

#### **BRAKES**

Airplane brakes are located on the main wheels and are applied by either a hand control or by foot pedals (toe or heel). Foot pedals operate independently and allow for differential braking. During ground operations, differential braking can supplement nosewheel/tailwheel steering.

#### **AUTOPILOT**

Autopilots are designed to control the aircraft and help reduce the pilot's workload. The limitations of the autopilot depend on the complexity of the system. The



**Figure 5-28. Fixed and retractable gear airplanes.**



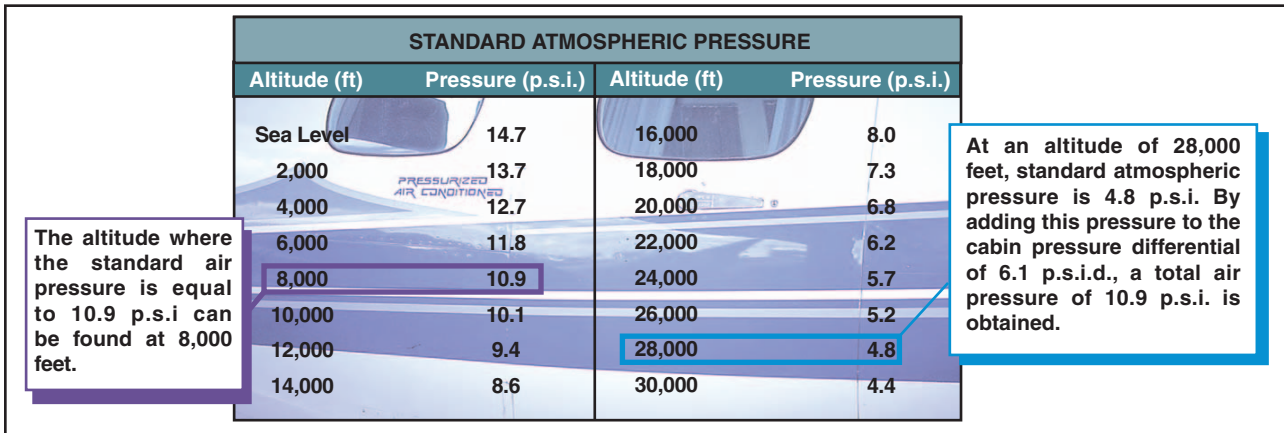
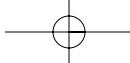

Figure 5-29. Standard atmospheric pressure chart.

common features available on an autopilot are altitude and heading hold. More advanced systems may include a vertical speed and/or indicated airspeed hold mode. Most autopilot systems are coupled to navigational aids.

An autopilot system consists of servos that actuate the flight controls. The number and location of these servos depends on the complexity of the system. For example, a single-axis autopilot controls the aircraft about the longitudinal axis and a servo actuates the ailerons. A three-axis autopilot controls the aircraft about the longitudinal, lateral, and vertical axes; and three different servos actuate the ailerons, the elevator, and the rudder.

The autopilot system also incorporates a disconnect safety feature to automatically or manually disengage the system. Autopilots can also be manually overridden. Because autopilot systems differ widely in their operation, refer to the autopilot operating instructions in the AFM or POH.

## PRESSURIZED AIRPLANES

When an airplane is flown at a high altitude, it consumes less fuel for a given airspeed than it does for the same speed at a lower altitude. In other words, the airplane is more efficient at a high altitude. In addition, bad weather and turbulence may be avoided by flying in the relatively smooth air above the storms. Because of the advantages of flying at high altitudes, many modern general aviation-type airplanes are being designed to operate in that environment. It is important that pilots transitioning to such sophisticated equipment be familiar with at least the basic operating principles.

A cabin pressurization system accomplishes several functions in providing adequate passenger comfort and safety. It maintains a cabin pressure altitude of approximately 8,000 feet at the maximum designed cruising altitude of the airplane, and prevents rapid changes of cabin altitude that may be uncomfortable or

cause injury to passengers and crew. In addition, the pressurization system permits a reasonably fast exchange of air from the inside to the outside of the cabin. This is necessary to eliminate odors and to remove stale air. [Figure 5-29]

Pressurization of the airplane cabin is an accepted method of protecting occupants against the effects of hypoxia. Within a pressurized cabin, occupants can be transported comfortably and safely for long periods of time, particularly if the cabin altitude is maintained at 8,000 feet or below, where the use of oxygen equipment is not required. The flight crew in this type of airplane must be aware of the danger of accidental loss of cabin pressure and must be prepared to deal with such an emergency whenever it occurs.

In the typical pressurization system, the cabin, flight compartment, and baggage compartments are incorporated into a sealed unit that is capable of containing air under a pressure higher than outside atmospheric pressure. On aircraft powered by turbine engines, bleed air from the engine compressor section is used to pressurize the cabin. Superchargers may be used on older model turbine powered airplanes to pump air into the sealed fuselage. Piston-powered airplanes may use air supplied from each engine turbocharger through a sonic venturi (flow limiter). Air is released from the fuselage by a device called an outflow valve. The outflow valve, by regulating the air exit, provides a constant inflow of air to the pressurized area. [Figure 5-30]

To understand the operating principles of pressurization and air-conditioning systems, it is necessary to become familiar with some of the related terms and definitions, such as:

- **Aircraft altitude**—the actual height above sea level at which the airplane is flying.
- **Ambient temperature**—the temperature in the area immediately surrounding the airplane.

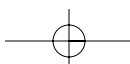



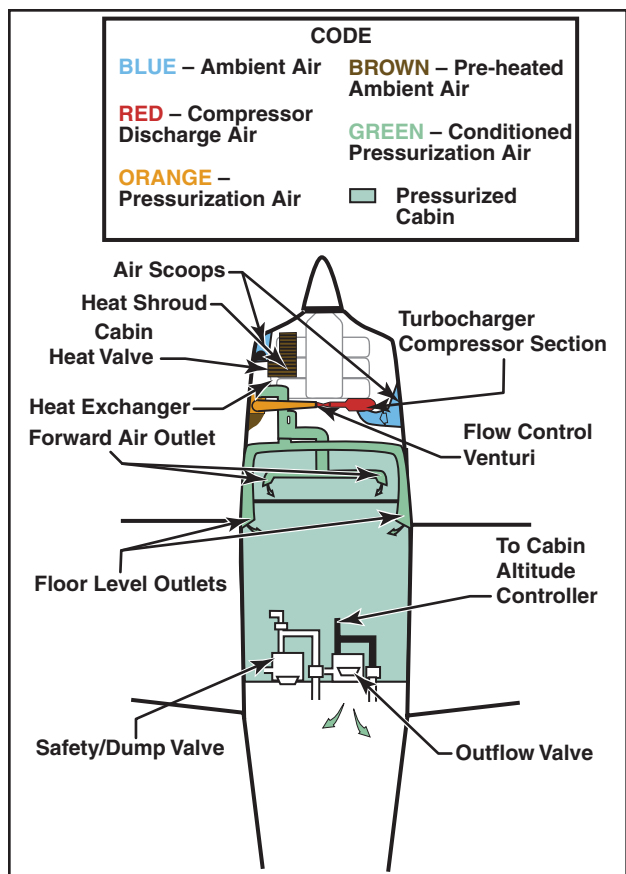

Figure 5-30. High performance airplane pressurization system.

- **Ambient pressure**—the pressure in the area immediately surrounding the airplane.
- **Cabin altitude**—used to express cabin pressure in terms of equivalent altitude above sea level.
- **Differential pressure**—the difference in pressure between the pressure acting on one side of a wall and the pressure acting on the other side of the wall. In aircraft air-conditioning and pressurizing systems, it is the difference between cabin pressure and atmospheric pressure.

The cabin pressure control system provides cabin pressure regulation, pressure relief, vacuum relief, and the means for selecting the desired cabin altitude in the isobaric and differential range. In addition, dumping of the cabin pressure is a function of the pressure control system. A cabin pressure regulator, an outflow valve, and a safety valve are used to accomplish these functions.

The cabin pressure regulator controls cabin pressure to a selected value in the isobaric range and limits cabin pressure to a preset differential value in the differential range. When the airplane reaches the altitude at which the difference between the pressure inside and outside the cabin is equal to the highest differential pressure for

which the fuselage structure is designed, a further increase in airplane altitude will result in a corresponding increase in cabin altitude. Differential control is used to prevent the maximum differential pressure, for which the fuselage was designed, from being exceeded. This differential pressure is determined by the structural strength of the cabin and often by the relationship of the cabin size to the probable areas of rupture, such as window areas and doors.

The cabin air pressure safety valve is a combination pressure relief, vacuum relief, and dump valve. The pressure relief valve prevents cabin pressure from exceeding a predetermined differential pressure above ambient pressure. The vacuum relief prevents ambient pressure from exceeding cabin pressure by allowing external air to enter the cabin when ambient pressure exceeds cabin pressure. The cockpit control switch actuates the dump valve. When this switch is positioned to ram, a solenoid valve opens, causing the valve to dump cabin air to atmosphere.

The degree of pressurization and the operating altitude of the aircraft are limited by several critical design factors. Primarily the fuselage is designed to withstand a particular maximum cabin differential pressure.

Several instruments are used in conjunction with the pressurization controller. The cabin differential pressure gauge indicates the difference between inside and outside pressure. This gauge should be monitored to assure that the cabin does not exceed the maximum allowable differential pressure. A cabin altimeter is also provided as a check on the performance of the system. In some cases, these two instruments are combined into one. A third instrument indicates the cabin rate of climb or descent. A cabin rate-of-climb instrument and a cabin altimeter are illustrated in Figure 5-31 on page 5-26.

Decompression is defined as the inability of the airplane's pressurization system to maintain its designed pressure differential. This can be caused by a malfunction in the pressurization system or structural damage to the airplane. Physiologically, decompressions fall into two categories; they are:

- **Explosive Decompression**—Explosive decompression is defined as a change in cabin pressure faster than the lungs can decompress; therefore, it is possible that lung damage may occur. Normally, the time required to release air from the lungs without restrictions, such as masks, is 0.2 seconds. Most authorities consider any decompression that occurs in less than 0.5 seconds as explosive and potentially dangerous.

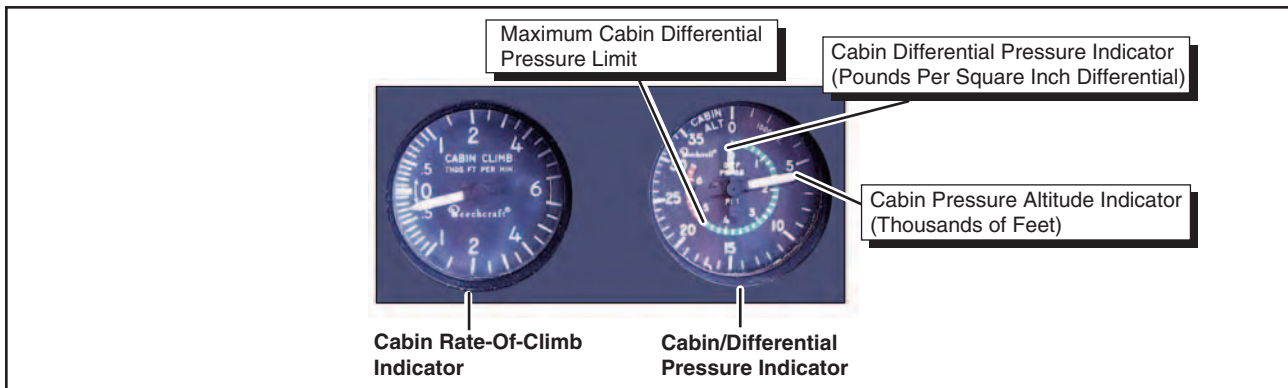

Figure 5-31. Cabin pressurization instruments.

- **Rapid Decompression**—Rapid decompression is defined as a change in cabin pressure where the lungs can decompress faster than the cabin; therefore, there is no likelihood of lung damage.

During an explosive decompression, there may be noise, and for a split second, one may feel dazed. The cabin air will fill with fog, dust, or flying debris. Fog occurs due to the rapid drop in temperature and the change of relative humidity. Normally, the ears clear automatically. Air will rush from the mouth and nose due to the escape of air from the lungs, and may be noticed by some individuals.

The primary danger of decompression is hypoxia. Unless proper utilization of oxygen equipment is accomplished quickly, unconsciousness may occur in a very short time. The period of useful consciousness is considerably shortened when a person is subjected to a rapid decompression. This is due to the rapid reduction of pressure on the body—oxygen in the lungs is exhaled rapidly. This in effect reduces the partial pressure of oxygen in the blood and therefore reduces the pilot's effective performance time by one-third to one-fourth its normal time. For this reason, the oxygen mask should be worn when flying at very high altitudes (35,000 feet or higher). It is recommended that the crewmembers select the 100 percent oxygen setting on the oxygen regulator at high altitude if the airplane is equipped with a demand or pressure demand oxygen system.

Another hazard is being tossed or blown out of the airplane if near an opening. For this reason, individuals near openings should wear safety harnesses or seatbelts at all times when the airplane is pressurized and they are seated.

Another potential hazard during high altitude decompressions is the possibility of evolved gas decompression sicknesses. Exposure to wind blasts and extremely cold temperatures are other hazards one might have to face.

Rapid descent from altitude is necessary if these problems are to be minimized. Automatic visual and aural warning systems are included in the equipment of all pressurized airplanes.

## OXYGEN SYSTEMS

Most high altitude airplanes come equipped with some type of fixed oxygen installation. If the airplane does not have a fixed installation, portable oxygen equipment must be readily accessible during flight. The portable equipment usually consists of a container, regulator, mask outlet, and pressure gauge. Aircraft oxygen is usually stored in high pressure system containers of 1,800 – 2,200 pounds per square inch (p.s.i.). When the ambient temperature surrounding an oxygen cylinder decreases, pressure within that cylinder will decrease because pressure varies directly with temperature if the volume of a gas remains constant. If a drop in indicated pressure on a supplemental oxygen cylinder is noted, there is no reason to suspect depletion of the oxygen supply, which has simply been compacted due to storage of the containers in an unheated area of the aircraft. High pressure oxygen containers should be marked with the p.s.i. tolerance (i.e., 1,800 p.s.i.) before filling the container to that pressure. The containers should be supplied with aviation oxygen only, which is 100 percent pure oxygen. Industrial oxygen is not intended for breathing and may contain impurities, and medical oxygen contains water vapor that can freeze in the regulator when exposed to cold temperatures. To assure safety, oxygen system periodic inspection and servicing should be done.

An oxygen system consists of a mask and a regulator that supplies a flow of oxygen dependent upon cabin altitude. Regulators approved for use up to 40,000 feet are designed to provide zero percent cylinder oxygen and 100 percent cabin air at cabin altitudes of 8,000 feet or less, with the ratio changing to 100 percent oxygen and zero percent cabin air at approximately 34,000 feet cabin altitude. Regulators approved up to 45,000 feet are designed to provide 40 percent cylinder oxygen and 60 percent cabin air at lower altitudes, with

the ratio changing to 100 percent at the higher altitude. Pilots should avoid flying above 10,000 feet without oxygen during the day and above 8,000 feet at night. [Figure 5-32]



Figure 5-32. Oxygen system regulator.

Pilots should be aware of the danger of fire when using oxygen. Materials that are nearly fireproof in ordinary air may be susceptible to burning in oxygen. Oils and greases may catch fire if exposed to oxygen, and cannot be used for sealing the valves and fittings of oxygen equipment. Smoking during any kind of oxygen equipment use is prohibited. Before each flight, the pilot should thoroughly inspect and test all oxygen equipment. The inspection should include a thorough examination of the aircraft oxygen equipment, including available supply, an operational check of the system, and assurance that the supplemental oxygen is readily accessible. The inspection should be accomplished with clean hands and should include a visual inspection of the mask and tubing for tears, cracks, or deterioration; the regulator for valve and lever condition and positions; oxygen quantity; and the location and functioning of oxygen pressure gauges, flow indicators and connections. The mask should be donned and the system should be tested. After any oxygen use, verify that all components and valves are shut off.

## MASKS

There are numerous types of oxygen masks in use that vary in design detail. It would be impractical to discuss all of the types in this handbook. It is important that the masks used be compatible with the particular oxygen system involved. Crew masks are fitted to the user's face with a minimum of leakage. Crew masks usually contain a microphone. Most masks are the oronasal-type, which covers only the mouth and nose.

Passenger masks may be simple, cup-shaped rubber moldings sufficiently flexible to obviate individual fitting. They may have a simple elastic head strap or

the passenger may hold them to the face.

All oxygen masks should be kept clean. This reduces the danger of infection and prolongs the life of the mask. To clean the mask, wash it with a mild soap and water solution and rinse it with clear water. If a microphone is installed, use a clean swab, instead of running water, to wipe off the soapy solution. The mask should also be disinfected. A gauze pad that has been soaked in a water solution of Merthiolate can be used to swab out the mask. This solution should contain one-fifth teaspoon of Merthiolate per quart of water. Wipe the mask with a clean cloth and air dry.

## DILUTER DEMAND OXYGEN SYSTEMS

Diluter demand oxygen systems supply oxygen only when the user inhales through the mask. An automix lever allows the regulators to automatically mix cabin air and oxygen or supply 100 percent oxygen, depending on the altitude. The demand mask provides a tight seal over the face to prevent dilution with outside air and can be used safely up to 40,000 feet. A pilot who has a beard or mustache should be sure it is trimmed in a manner that will not interfere with the sealing of the oxygen mask. The fit of the mask around the beard or mustache should be checked on the ground for proper sealing.

## PRESSURE DEMAND OXYGEN SYSTEMS

Pressure demand oxygen systems are similar to diluter demand oxygen equipment, except that oxygen is supplied to the mask under pressure at cabin altitudes above 34,000 feet. Pressure demand regulators also create airtight and oxygen-tight seals, but they also provide a positive pressure application of oxygen to the mask face piece that allows the user's lungs to be pressurized with oxygen. This feature makes pressure demand regulators safe at altitudes above 40,000 feet. Some systems may have a pressure demand mask with the regulator attached directly to the mask, rather than mounted on the instrument panel or other area within the flight deck. The mask-mounted regulator eliminates the problem of a long hose that must be purged of air before 100 percent oxygen begins flowing into the mask.

## CONTINUOUS FLOW OXYGEN SYSTEM

Continuous flow oxygen systems are usually provided for passengers. The passenger mask typically has a reservoir bag, which collects oxygen from the continuous flow oxygen system during the time when the mask user is exhaling. The oxygen collected in the reservoir bag allows a higher aspiratory flow rate during the inhalation cycle, which reduces the amount of air dilution. Ambient air is added to the supplied



oxygen during inhalation after the reservoir bag oxygen supply is depleted. The exhaled air is released to the cabin. [Figure 5-33]

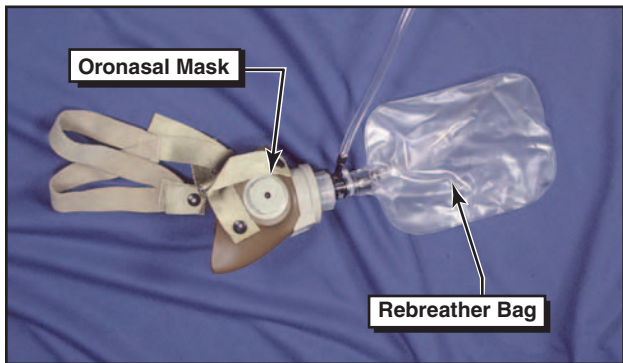

Figure 5-33. Continuous flow mask and rebreather bag.

### SERVICING OF OXYGEN SYSTEMS

Certain precautions should be observed whenever aircraft oxygen systems are to be serviced. Before servicing any aircraft with oxygen, consult the specific aircraft service manual to determine the type of equipment required and procedures to be used. Oxygen system servicing should be accomplished only when the aircraft is located outside of the hangars. Personal cleanliness and good housekeeping are imperative when working with oxygen. Oxygen under pressure and petroleum products create spontaneous results when they are brought in contact with each other. Service people should be certain to wash dirt, oil, and grease (including lip salves and hair oil) from their hands before working around oxygen equipment. It is also essential that clothing and tools are free of oil, grease, and dirt. Aircraft with permanently installed oxygen tanks usually require two persons to accomplish servicing of the system. One should be stationed at the service equipment control valves, and the other stationed where he or she can observe the aircraft system pressure gauges. Oxygen system servicing is not recommended during aircraft fueling operations or while other work is performed that could provide a source of ignition. Oxygen system servicing while passengers are on board the aircraft is not recommended.

### ICE CONTROL SYSTEMS

Ice control systems installed on aircraft consist of anti-ice and de-ice equipment. Anti-icing equipment is designed to prevent the formation of ice, while de-icing equipment is designed to remove ice once it has formed. Ice control systems protect the leading edge of wing and tail surfaces, pitot and static port openings, fuel tank vents, stall warning devices, windshields, and propeller blades. Ice detection lighting may also be installed on some airplanes to determine the extent of structural icing during night flights. Since many airplanes are not certified for flight in icing conditions, refer to the AFM or POH for details.

### AIRFOIL ICE CONTROL

Inflatable de-icing boots consist of a rubber sheet bonded to the leading edge of the airfoil. When ice builds up on the leading edge, an engine-driven pneumatic pump inflates the rubber boots. Some turboprop aircraft divert engine bleed air to the wing to inflate the rubber boots. Upon inflation, the ice is cracked and should fall off the leading edge of the wing. De-icing boots are controlled from the cockpit by a switch and can be operated in a single cycle or allowed to cycle at automatic, timed intervals. It is important that de-icing boots are used in accordance with the manufacturer's recommendations. If they are allowed to cycle too often, ice can form over the contour of the boot and render the boots ineffective. [Figure 5-34]

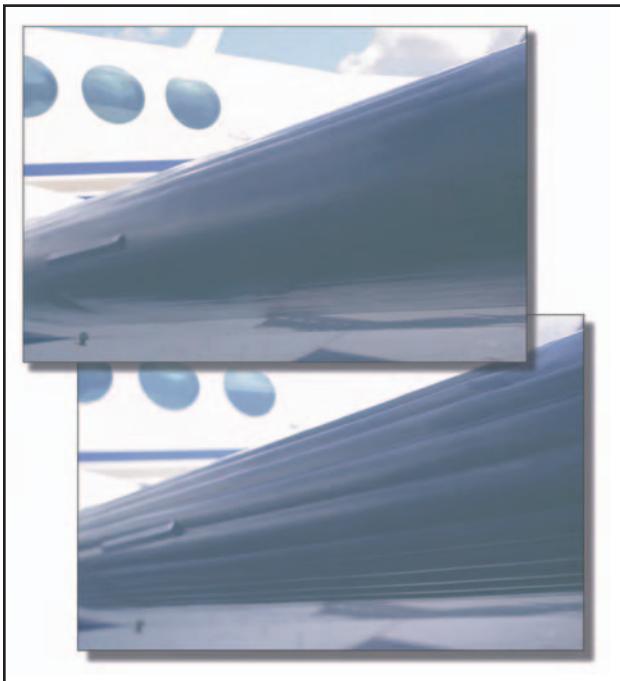

Figure 5-34. De-icing boots on the leading edge of the wing.

Many de-icing boot systems use the instrument system suction gauge and a pneumatic pressure gauge to indicate proper boot operation. These gauges have range markings that indicate the operating limits for boot operation. Some systems may also incorporate an annunciator light to indicate proper boot operation.

Proper maintenance and care of de-icing boots is important for continued operation of this system. They need to be carefully inspected prior to a flight.

Another type of leading edge protection is the thermal anti-ice system installed on airplanes with turbine engines. This system is designed to prevent the buildup of ice by directing hot air from the compressor section of the engine to the leading edge surfaces. The system is activated prior to entering icing conditions. The hot air heats the leading edge sufficiently to prevent the formation of ice.



An alternate type of leading edge protection that is not as common as thermal anti-ice and de-icing boots is known as a weeping wing. The weeping-wing design uses small holes located in the leading edge of the wing. A chemical mixture is pumped to the leading edge and weeps out through the holes to prevent the formation and buildup of ice.

#### WINDSCREEN ICE CONTROL

There are two main types of windscreen anti-ice systems. The first system directs a flow of alcohol to the windscreen. By using it early enough, the alcohol will prevent ice from building up on the windshield. The rate of alcohol flow can be controlled by a dial in the cockpit according to procedures recommended by the airplane manufacturer.

Another effective method of anti-icing equipment is the electric heating method. Small wires or other conductive material is imbedded in the windscreen. The heater can be turned on by a switch in the cockpit, at which time electrical current is passed across the shield through the wires to provide sufficient heat to prevent the formation of ice on the windscreen. The electrical current can cause compass deviation errors; in some cases, as much as 40°. The heated windscreen should only be used during flight. Do not leave it on during ground operations, as it can overheat and cause damage to the windscreen.

#### PROPELLER ICE CONTROL

Propellers are protected from icing by use of alcohol or electrically heated elements. Some propellers are equipped with a discharge nozzle that is pointed toward the root of the blade. Alcohol is discharged from the nozzles, and centrifugal force makes the alcohol flow down the leading edge of the blade. This prevents ice from forming on the leading edge of the propeller. Propellers can also be fitted with propeller anti-ice boots. The propeller boot is divided into two sections—the inboard and the outboard sections. The boots are grooved to help direct the flow of alcohol, and they are also imbedded with electrical wires that carry current for heating the propeller. The prop anti-ice system can be monitored for proper operation by monitoring the prop anti-ice ammeter. During the preflight inspection, check the propeller boots for proper operation. If a boot fails to heat one blade, an unequal blade loading can result, and may cause severe propeller vibration. [Figure 5-35]

#### OTHER ICE CONTROL SYSTEMS

Pitot and static ports, fuel vents, stall-warning sensors, and other optional equipment may be heated by



Figure 5-35. Prop ammeter and anti-ice boots.

electrical elements. Operational checks of the electrically heated systems are to be checked in accordance with the AFM or POH.

Operation of aircraft anti-icing and de-icing systems should be checked prior to encountering icing conditions. Encounters with structural ice require immediate remedial action. Anti-icing and de-icing equipment is not intended to sustain long-term flight in icing conditions.

## TURBINE ENGINES

The turbine engine produces thrust by increasing the velocity of the air flowing through the engine. It consists of an air inlet, compressor, combustion chambers, turbine section, and exhaust. [Figure 5-36] The turbine

engine has the following advantages over a reciprocating engine: less vibration, increased aircraft performance, reliability, and ease of operation.

### TYPES OF TURBINE ENGINES

Turbine engines are classified according to the type of compressors they use. The compressor types fall into three categories—centrifugal flow, axial flow, and centrifugal-axial flow. Compression of inlet air is achieved in a centrifugal flow engine by accelerating air outward perpendicular to the longitudinal axis of the machine. The axial-flow engine compresses air by a series of rotating and stationary airfoils moving the air parallel to the longitudinal axis. The centrifugal-axial flow design uses both kinds of compressors to achieve the desired compression.

The path the air takes through the engine and how power is produced determines the type of engine. There are four types of aircraft turbine engines—turbojet, turboprop, turbofan, and turboshaft.

### TURBOJET

The turbojet engine contains four sections: compressor, combustion chamber, turbine section, and exhaust. The compressor section passes inlet air at a high rate of speed to the combustion chamber. The combustion chamber contains the fuel inlet and igniter for combustion. The expanding air drives a turbine, which is connected by a shaft to the compressor, sustaining engine operation. The accelerated exhaust gases from the engine provide thrust. This is a basic application of compressing air, igniting the fuel-air mixture, producing power to self-sustain the engine operation, and exhaust for propulsion.

Turbojet engines are limited on range and endurance.

They are also slow to respond to throttle applications at slow compressor speeds.

### TURBOPROP

A turboprop engine is a turbine engine that drives a propeller through a reduction gear. The exhaust gases drive a power turbine connected by a shaft that drives the reduction gear assembly. Reduction gearing is necessary in turboprop engines because optimum propeller performance is achieved at much slower speeds than the engine's operating r.p.m. Turboprop engines are a compromise between turbojet engines and reciprocating powerplants. Turboprop engines are most efficient at speeds between 250 and 400 m.p.h. and altitudes between 18,000 and 30,000 feet. They also perform well at the slow airspeeds required for takeoff and landing, and are fuel efficient. The minimum specific fuel consumption of the turboprop engine is normally available in the altitude range of 25,000 feet to the tropopause.

### TURBOFAN

Turbofans were developed to combine some of the best features of the turbojet and the turboprop. Turbofan engines are designed to create additional thrust by diverting a secondary airflow around the combustion chamber. The turbofan bypass air generates increased thrust, cools the engine, and aids in exhaust noise suppression. This provides turbojet-type cruise speed and lower fuel consumption.

The inlet air that passes through a turbofan engine is usually divided into two separate streams of air. One stream passes through the engine core, while a second stream bypasses the engine core. It is this bypass stream of air that is responsible for the term "bypass engine." A turbofan's bypass ratio refers to the ratio of the mass airflow that passes through the fan divided by the mass airflow that passes through the engine core.

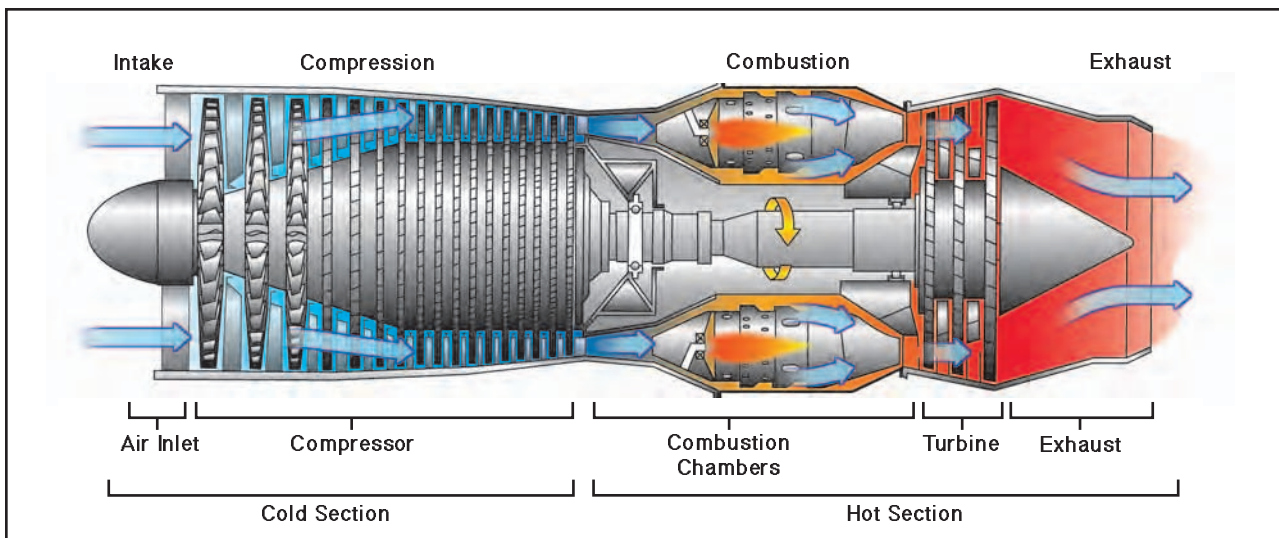

Figure 5-36. Basic components of a turbine engine.

## TURBOSHAFT

The fourth common type of jet engine is the turboshaft. It delivers power to a shaft that drives something other than a propeller. The biggest difference between a turbojet and turboshaft engine is that on a turboshaft engine, most of the energy produced by the expanding gases is used to drive a turbine rather than produce thrust. Many helicopters use a turboshaft gas turbine engine. In addition, turboshaft engines are widely used as auxiliary power units on large aircraft.

## PERFORMANCE COMPARISON

It is possible to compare the performance of a reciprocating powerplant and different types of turbine engines. However, for the comparison to be accurate, thrust horsepower (usable horsepower) for the reciprocating powerplant must be used rather than brake horsepower, and net thrust must be used for the turbine-powered engines. In addition, aircraft design configuration, and size must be approximately the same.

**BHP—** Brake horsepower is the horsepower actually delivered to the output shaft. Brake horsepower is the actual usable horsepower.

**Net Thrust—** The thrust produced by a turbojet or turbofan engine.

**THP—** Thrust horsepower is the horsepower equivalent of the thrust produced by a turbojet or turbofan engine.

**ESHP—** Equivalent shaft horsepower, with respect to turboprop engines, is the sum of the shaft horsepower (SHP) delivered to the propeller and the thrust horsepower (THP) produced by the exhaust gases.

Figure 5-37 shows how four types of engines compare in net thrust as airspeed is increased. This figure is for explanatory purposes only and is not for specific models of engines. The four types of engines are:

- Reciprocating powerplant.
- Turbine, propeller combination (turboprop).
- Turbine engine incorporating a fan (turbofan).
- Turbojet (pure jet).

The comparison is made by plotting the performance curve for each engine, which shows how maximum aircraft speed varies with the type of engine used. Since the graph is only a means of comparison, numerical values for net thrust, aircraft speed, and drag are not included.

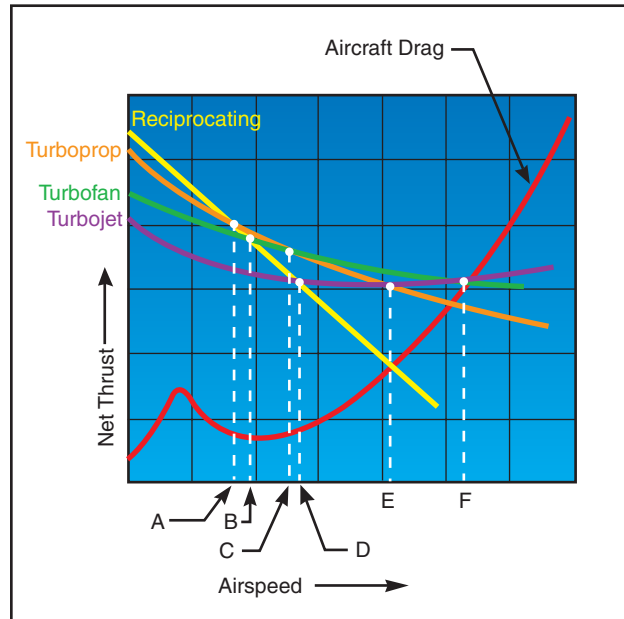

Figure 5-37. Engine net thrust versus aircraft speed and drag.

Comparison of the four powerplants on the basis of net thrust makes certain performance capabilities evident. In the speed range shown to the left of Line A, the reciprocating powerplant outperforms the other three types. The turboprop outperforms the turbofan in the range to the left of Line C. The turbofan engine outperforms the turbojet in the range to the left of Line F. The turbofan engine outperforms the reciprocating powerplant to the right of Line B and the turboprop to the right of Line C. The turbojet outperforms the reciprocating powerplant to the right of Line D, the turboprop to the right of Line E, and the turbofan to the right of Line F.

The points where the aircraft drag curve intersects the net thrust curves are the maximum aircraft speeds. The vertical lines from each of the points to the baseline of the graph indicate that the turbojet aircraft can attain a higher maximum speed than aircraft equipped with the other types of engines. Aircraft equipped with the turbofan engine will attain a higher maximum speed than aircraft equipped with a turboprop or reciprocating powerplant.

## TURBINE ENGINE INSTRUMENTS

Engine instruments that indicate oil pressure, oil temperature, engine speed, exhaust gas temperature, and fuel flow are common to both turbine and reciprocating engines. However, there are some instruments that are unique to turbine engines. These instruments provide indications of engine pressure ratio, turbine discharge pressure, and torque. In addition, most gas turbine engines have multiple temperature-sensing instruments, called thermocouples, that provide pilots with temperature readings in and around the turbine section.



### ENGINE PRESSURE RATIO

An engine pressure ratio (EPR) gauge is used to indicate the power output of a turbojet/turbofan engine. EPR is the ratio of turbine discharge to compressor inlet pressure. Pressure measurements are recorded by probes installed in the engine inlet and at the exhaust. Once collected, the data is sent to a differential pressure transducer, which is indicated on a cockpit EPR gauge.

EPR system design automatically compensates for the effects of airspeed and altitude. However, changes in ambient temperature do require a correction to be applied to EPR indications to provide accurate engine power settings.

### EXHAUST GAS TEMPERATURE

A limiting factor in a gas turbine engine is the temperature of the turbine section. The temperature of a turbine section must be monitored closely to prevent overheating the turbine blades and other exhaust section components. One common way of monitoring the temperature of a turbine section is with an exhaust gas temperature (EGT) gauge. EGT is an engine operating limit used to monitor overall engine operating conditions.

Variations of EGT systems bear different names based on the location of the temperature sensors. Common turbine temperature sensing gauges include the turbine inlet temperature (TIT) gauge, turbine outlet temperature (TOT) gauge, interstage turbine temperature (ITT) gauge, and turbine gas temperature (TGT) gauge.

### TORQUEMETER

Turboprop/turboshaft engine power output is measured by the torque meter. Torque is a twisting force applied to a shaft. The torque meter measures power applied to the shaft. Turboprop and turboshaft engines are designed to produce torque for driving a propeller. Torque meters are calibrated in percentage units, foot-pounds, or pounds per square inch.

### $N_1$ INDICATOR

$N_1$  represents the rotational speed of the low pressure compressor and is presented on the indicator as a percentage of design r.p.m. After start the speed of the low pressure compressor is governed by the  $N_1$  turbine wheel. The  $N_1$  turbine wheel is connected to the low pressure compressor through a **concentric shaft**.

### $N_2$ INDICATOR

$N_2$  represents the rotational speed of the high pressure compressor and is presented on the indicator as a percentage of design r.p.m. The high pressure compressor is governed by the  $N_2$  turbine wheel. The

**Concentric Shaft**—One shaft inside another shaft having a common core.

$N_2$  turbine wheel is connected to the high pressure compressor through a concentric shaft. [Figure 5-38]

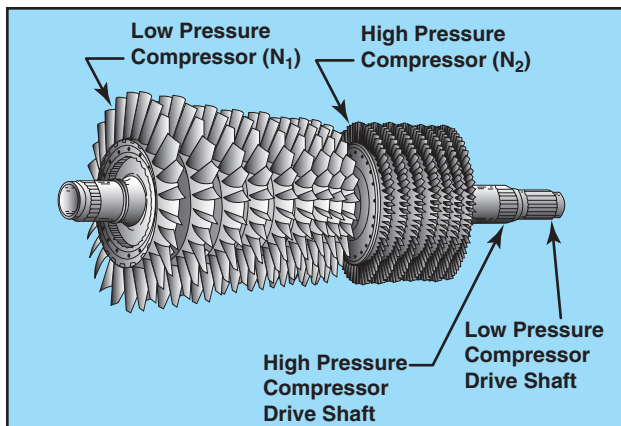

Figure 5-38. Dual-spool axial-flow compressor.

### TURBINE ENGINE OPERATIONAL CONSIDERATIONS

Because of the great variety of turbine engines, it is impractical to cover specific operational procedures. However, there are certain operational considerations that are common to all turbine engines. They are engine temperature limits, foreign object damage, hot start, compressor stall, and flameout.

### ENGINE TEMPERATURE LIMITATIONS

The highest temperature in any turbine engine occurs at the turbine inlet. Turbine inlet temperature is therefore usually the limiting factor in turbine engine operation.

### THRUST VARIATIONS

Turbine engine thrust varies directly with air density. As air density decreases, so does thrust. While both turbine and reciprocating powered engines are affected to some degree by high relative humidity, turbine engines will experience a negligible loss of thrust, while reciprocating engines a significant loss of brake horsepower.

### FOREIGN OBJECT DAMAGE

Due to the design and function of a turbine engine's air inlet, the possibility of ingestion of debris always exists. This causes significant damage, particularly to the compressor and turbine sections. When this occurs, it is called foreign object damage (FOD). Typical FOD consists of small nicks and dents caused by ingestion of small objects from the ramp, taxiway, or runway. However, FOD damage caused by bird strikes or ice ingestion can also occur, and may result in total destruction of an engine.

Prevention of FOD is a high priority. Some engine inlets have a tendency to form a vortex between the ground and the inlet during ground operations. A vortex dissipater may be installed on these engines.



Other devices, such as screens and/or deflectors, may also be utilized. Preflight procedures include a visual inspection for any sign of FOD.

### TURBINE ENGINE HOT/HUNG START

A hot start is when the EGT exceeds the safe limit. Hot starts are caused by too much fuel entering the combustion chamber, or insufficient turbine r.p.m. Any time an engine has a hot start, refer to the AFM, POH, or an appropriate maintenance manual for inspection requirements.

If the engine fails to accelerate to the proper speed after ignition or does not accelerate to idle r.p.m., a hung start has occurred. A hung start, may also be called a false start. A hung start may be caused by an insufficient starting power source or fuel control malfunction.

### COMPRESSOR STALLS

Compressor blades are small airfoils and are subject to the same aerodynamic principles that apply to any airfoil. A compressor blade has an angle of attack. The angle of attack is a result of inlet air velocity and the compressor's rotational velocity. These two forces combine to form a vector, which defines the airfoil's actual angle of attack to the approaching inlet air.

A compressor stall can be described as an imbalance between the two vector quantities, inlet velocity and compressor rotational speed. Compressor stalls occur when the compressor blades' angle of attack exceeds the critical angle of attack. At this point, smooth airflow is interrupted and turbulence is created with pressure fluctuations. Compressor stalls cause air flowing in the compressor to slow down and stagnate, sometimes reversing direction. [Figure 5-39]

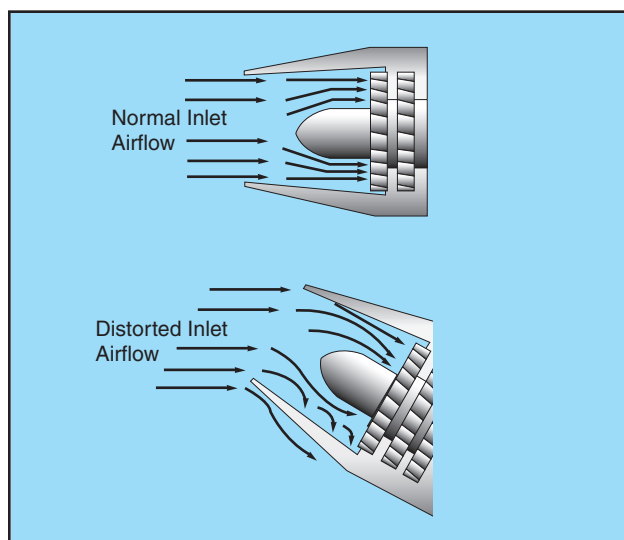

Figure 5-39. Comparison of normal and distorted airflow into the compressor section.

Compressor stalls can be transient and intermittent or steady state and severe. Indications of a transient/intermittent stall are usually an intermittent “bang” as backfire and flow reversal take place. If the stall develops and becomes steady, strong vibration and a loud roar may develop from the continuous flow reversal. Quite often the cockpit gauges will not show a mild or transient stall, but will indicate a developed stall. Typical instrument indications include fluctuations in r.p.m., and an increase in exhaust gas temperature. Most transient stalls are not harmful to the engine and often correct themselves after one or two pulsations. The possibility of engine damage, which may be severe, from a steady state stall is immediate. Recovery must be accomplished quickly by reducing power, decreasing the airplane's angle of attack and increasing airspeed.

Although all gas turbine engines are subject to compressor stalls, most models have systems that inhibit these stalls. One such system uses variable inlet guide vane (VIGV) and variable stator vanes, which direct the incoming air into the rotor blades at an appropriate angle. The main way to prevent air pressure stalls is to operate the airplane within the parameters established by the manufacturer. If a compressor stall does develop, follow the procedures recommended in the AFM or POH.

### FLAMEOUT

A flameout is a condition in the operation of a gas turbine engine in which the fire in the engine unintentionally goes out. If the rich limit of the fuel/air ratio is exceeded in the combustion chamber, the flame will blow out. This condition is often referred to as a rich flameout. It generally results from very fast engine acceleration, where an overly rich mixture causes the fuel temperature to drop below the combustion temperature. It also may be caused by insufficient airflow to support combustion.

Another, more common flameout occurrence is due to low fuel pressure and low engine speeds, which typically are associated with high-altitude flight. This situation also may occur with the engine throttled back during a descent, which can set up the lean-condition flameout. A weak mixture can easily cause the flame to die out, even with a normal airflow through the engine.

Any interruption of the fuel supply also can result in a flameout. This may be due to prolonged unusual attitudes, a malfunctioning fuel control system, turbulence, icing or running out of fuel.

Symptoms of a flameout normally are the same as those following an engine failure. If the flameout is due to a transitory condition, such as an imbalance between fuel flow and engine speed, an airstart may be

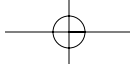

attempted once the condition is corrected. In any case, pilots must follow the applicable emergency procedures outlined in the AFM or POH. Generally,

these procedures contain recommendations concerning altitude and airspeed where the airstart is most likely to be successful.

